

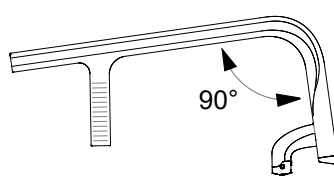

Data	Italia	
Utilizzatore	Timbro ditta	Carrozzina superleggera rigida Riconducibile N.T. Cod. 12.21.06.060
Peso utilizzatore (kg)		€
Lingua manuale d'uso	Responsabile	Prezzo al pubblico IVA esclusa

Misure carrozzina	
Larghezza sedile (LS) <input type="checkbox"/> 33 <input type="checkbox"/> 36 <input type="checkbox"/> 39 <input type="checkbox"/> 42 <input type="checkbox"/> 45 <input type="checkbox"/> 48	La larghezza della seduta è misurata all'esterno dei tubi telaio, mentre la distanza interna tra le due spondine risulta più larga di circa 1,5 cm.
Profondità sedile (PS) <input type="checkbox"/> 35 <input type="checkbox"/> 37,5 <input type="checkbox"/> 40 <input type="checkbox"/> 42,5 <input type="checkbox"/> 45 <input type="checkbox"/> 47,5 <input type="checkbox"/> 50	La profondità seduta effettiva misurata da inizio tela sedile a tubo schienale risulta maggiorata di 1,5 cm
Distanza pedana (DP) (cm) ±0,5cm - step di regolazione 1,5cm	(Distanza tela sedile - piatto pedana) - ATTENZIONE! Altezza anteriore minimo 4 cm. maggiore della DISTANZA PEDANA
Assetto <input checked="" type="checkbox"/> Standard <input type="checkbox"/> Prudente <input type="checkbox"/> Attivo	
Altezza schienale (TS) Val.Standard 33,5(min 24.5-max 47) step di regolazione 1,5cm	
Campanatura <input checked="" type="checkbox"/> 0° <input type="checkbox"/> 2° <input type="checkbox"/> 4°	

Telaio anteriore ☆ Telaio monoscocca in fibra di carbonio, Angolo 90° rispetto alla seduta	
--	---

ALTEZZA ANTERIORE - Barrare la cella con l'altezza desiderata
 La differenza di altezze realizzabili tra il Telaio ALTO e BASSO è di 3cm. (a parità di: Forcella, ruota anteriore e foro di montaggio).

	 Forcella SPORT (H95)	 Forcella piccola (H115)
TELAIO BASSO 90° Altezza anteriore (min 44,5 - max 50) Distanza pedana (min 34,5) <div style="border: 1px solid red; padding: 2px; color: red; font-size: small;"> U-TUBE Pedana di alluminio Distanza pedana (min 18 ÷ max 35) DPmax = Altezza anteriore - 10cm </div>	Ruote anteriori 3" <input type="checkbox"/> ~45 <input type="checkbox"/> ~46 4" <input type="checkbox"/> ~46 <input type="checkbox"/> ~47 5" <input type="checkbox"/> ~48,5	Ruote anteriori 3" <input type="checkbox"/> ~45,5 <input type="checkbox"/> ~47 4" <input type="checkbox"/> ~46,5 <input type="checkbox"/> ~48 <input type="checkbox"/> ~49 5" <input type="checkbox"/> ~49 <input type="checkbox"/> ~50
TELAIO ALTO 90° Altezza anteriore (min 47,5 - max 53) Distanza pedana (min 37,5) <div style="border: 1px solid red; padding: 2px; color: red; font-size: small;"> U-TUBE Pedana di alluminio Distanza pedana (min 21 ÷ max 38) DPmax = Altezza anteriore - 10cm </div>	Ruote anteriori 3" <input type="checkbox"/> ~48 <input type="checkbox"/> ~49 4" <input type="checkbox"/> ~49 <input type="checkbox"/> ~50 5" <input type="checkbox"/> ~51,5	Ruote anteriori 3" <input type="checkbox"/> ~48,5 <input type="checkbox"/> ~50 4" <input type="checkbox"/> ~49,5 <input type="checkbox"/> ~51 <input type="checkbox"/> ~52 5" <input type="checkbox"/> ~52 <input type="checkbox"/> ~53

L'altezza anteriore effettiva potrebbe risultare diversa da quella scelta in quanto il suo valore subisce delle leggere variazioni date dalla combinazione con profondità e altezza posteriore.

ALTEZZA POSTERIORE La differenza tra Altezza Anteriore e Altezza Posteriore deve essere compresa tra 3 e 12cm

- Ruote posteriori 22" (min 36 - max 44)
- Ruote posteriori 24" (min 38 - max 46)
- Ruote posteriori 25" (min 39 - max 47)
- Ruote posteriori 26" (min 41 - max 48)

Seduta	
☆ Tela sedile con tasca porta oggetti (sotto seduta)	
<input type="radio"/> Seduta a fasce tensionabili	08883 220,00
<input type="radio"/> Seduta rigida in carbonio	08336 450,00
<input type="radio"/> Tasca porta oggetti (sotto seduta) [25x11x4,5]	08281 70,00

Rehateam s.r.l. - Via Negrini, 5 - 31038 Castagnole di Paese (TV) - Tel. +39.0422.484657/+39.0422.480387 - Fax +39.0422.484661/+39.0422.484684 - P.IVA IT 03182520266 - C.C.I.A.A. TV n.225867 - Iscr. Trib. TV n.41690 Capitale Sociale I.V. Euro 100.000,00
 la società è soggetta ex art. 2497-bis C.C. al coordinamento e direzione della società "PERMOBIL ITALY SRL" iscritta al Registro Imprese Milano Monza Brianza Lodi 10246110968

Email: info_it@permobil.com - web: http://www.rehateamprogeo.com

Data Comnessa Utilizzatore Indirizzo

CUSTOMIZE COLORS

① Colore forcella

☆ Nero opaco

- Argento brillante
- Antracite brillante
- Bianco perlato
- Rosso brillante
- Arancio brillante
- Azzurro brillante
- Fucsia brillante
- Lime brillante

08342 70,00

② Colore ruote posteriori

Abbinabile solo con: Ruote posteriori Superleggera Standard Progeo (22 - 24)

☆ Nero

- Argento brillante
- Antracite brillante
- Bianco perlato
- Rosso brillante
- Arancio brillante
- Azzurro brillante
- Fucsia brillante
- Lime brillante

04692 70,00

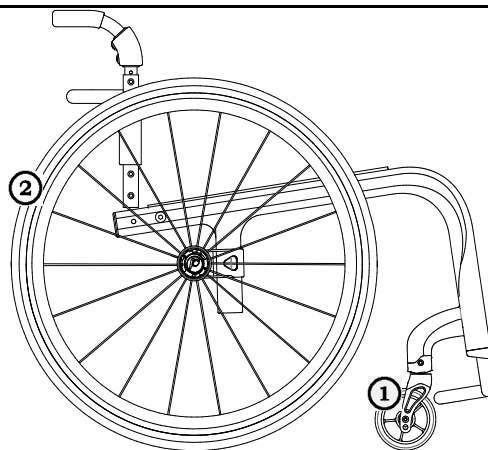

Asse ruote posteriori

- ☆ Asse ruote posteriori in alluminio
- Asse ruote posteriori in Carbonio

(Configurazione più leggera)

07647 160,00

Sistema di regolazione e fissaggio schienale

- ☆ Schienale con bloccaggio in apertura e chiusura
- Schienale con bloccaggio solo in apertura
- Schienale fisso (non abbattibile)

con regolazione dell'inclinazione da -4° a +16°
con regolazione dell'inclinazione da -4° a +16°
con regolazione dell'inclinazione da -4° a +16°

Schienale

☆ Imbottitura tensionabile traspirante

☆ Schienale in alluminio

Schienale in titanio

Schienale in carbonio



06811 200,00

04389 660,00

Schienale posturale integrato (NON REMOVIBILE)

Guscio CARBONIO - Contenimento laterale 7,5cm
Regolazione in profondità ±1cm. - Regolazione inclinazione ±10°
non disponibile per larghezza 48

Installazione su:

☆ Tubi schienale

Schienale in alluminio

Schienale in titanio

Schienale in carbonio



06811 200,00

04389 660,00

H 28		H 34		H 40	
Altezza schienale (TS) min 34		Altezza schienale (TS) min 38		Altezza schienale (TS) min 44	
(.....)		(.....)		(.....)	
Ala di contenimento laterale A=alta - R=regolare					
A	R	A	R	A	R
<input type="checkbox"/>	<input type="checkbox"/>	<input type="checkbox"/>	<input type="checkbox"/>	<input type="checkbox"/>	<input type="checkbox"/>

Tubi maniglia

☆ Tubi con maniglia standard

Tubi con maniglia corta

Tubi SPORT (Senza maniglie)

Tubi in carbonio con maniglia corta **Riduzione del peso circa 110gr.**

Non disponibile con: Schienale posturale PHYSIO - Schienale posturale A I R

04390 140,00



Maniglie ribaltabili



02958 220,00

Rehateam s.r.l. - Vicolo Negrelli, 5 - 31038 Castagnole di Paese (TV) - Tel. +39 0422 484657/+39 0422 480387 - Fax +39 0422 484661/+39 0422 484684 - P.IVA IT 03182520266 - C.C.I.A.A. TV n.225867 - Iscr.Trib. TV n.41890 Capitale Sociale I.V. Euro 100.000,00
 la società è soggetta ex art. 2497-bis C.C. al coordinamento e direzione della società "PERMOBIL ITALY SRL" iscritta al Registro Imprese Milano Monza Brianza Lodi 10246110968

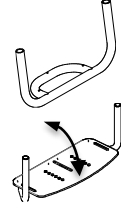
Data	Commessa	Utilizzatore	Indirizzo
------------	----------------	--------------------	-----------------

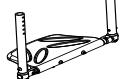
Pedana			
<input checked="" type="checkbox"/>	Pedana in alluminio. Non regolabile in inclinazione		
<input checked="" type="checkbox"/>	Pedana di alluminio	<input type="checkbox"/>	con piatto in plastica
<input type="checkbox"/>	Pedana unica alzabile in alluminio FLIP-BACK! - regolabile in profondità e inclinazione		09420 220,00
<input type="checkbox"/>	Pedana in alluminio, regolabile in profondità e inclinazione		04456 240,00
<input checked="" type="checkbox"/>	interna	<input type="checkbox"/>	2/3 interna
		<input type="checkbox"/>	esterna
		<input type="checkbox"/>	2/3 esterna
<input type="checkbox"/>	U-TUBE - Pedana in alluminio, regolabile in profondità e inclinazione		09853 220,00
	TELAIO BASSO: distanza pedana minima possibile 18 - distanza pedana massima possibile 35		
	TELAIO ALTO: distanza pedana minima possibile 21 - distanza pedana massima possibile 38		
<input type="checkbox"/>	Pedana unica in carbonio. Regolabile in inclinazione		04110 330,00
<input checked="" type="checkbox"/>	interna	<input type="checkbox"/>	esterna













Protezione vestiario			
<input checked="" type="checkbox"/>	Parafango Carbonio		
<input type="checkbox"/>	Protezione dritta Carbonio		
<input type="checkbox"/>	Versione estraibile		08921 110,00

Ruote anteriori			
<input checked="" type="checkbox"/>	4" Piena Soft		
<input type="checkbox"/>	3" Sport		
<input type="checkbox"/>	5" Piena Soft		
<input type="checkbox"/>	3" Active Soft (larga)	(Cerchio in lega di alluminio)	06824 120,00
<input type="checkbox"/>	4" Active Sport (stretta)	(Cerchio in lega di alluminio)	01398 120,00
<input type="checkbox"/>	4" Active Soft (larga)	(Cerchio in lega di alluminio)	03943 120,00
<input type="checkbox"/>	5" Active Soft (larga)	(Cerchio in lega di alluminio)	07518 120,00
<input type="checkbox"/>	5" Pneumatica		10844 60,00

Ruote posteriori			
<input checked="" type="checkbox"/>	24" Superleggera Standard Progeo		
<input type="checkbox"/>	22" Superleggera Standard Progeo		
<input type="checkbox"/>	25" Superleggera Standard Progeo	(solo colore nero)	
<input type="checkbox"/>	26" Superleggera Progeo	(solo colore nero)	
<input type="checkbox"/>	24" ULTRALEGGERA PROGEO KEY SPORT	Riduzione del peso circa 450gr.	04383 750,00
<input type="checkbox"/>	24" Superleggera "Spinergy LX"		01685 750,00
<input type="checkbox"/>	24" Superleggera "Spinergy LXL"	<input type="checkbox"/>	Raggi bianchi e mozzo nero
		<input type="checkbox"/>	Raggi e mozzo neri
<input type="checkbox"/>	24" Superleggera "Spinergy Flex rim"	Corrimano incorporato Alluminio/Gomma	02270 1.200,00
<input type="checkbox"/>	25" Superleggera "Spinergy LX"		02101 750,00
<input type="checkbox"/>	25" Superleggera "Spinergy LXL"	<input type="checkbox"/>	Raggi bianchi e mozzo nero
<input type="checkbox"/>	26" Superleggera "Spinergy LX"		02102 750,00
<input type="checkbox"/>	24" Fuoristrada (corrimano in alluminio nero)		01392 250,00

Copertura ruota posteriore			
<input checked="" type="checkbox"/>	Liscio Alta Pressione	(22"-24"-25"-26")	
<input type="checkbox"/>	Tassellato Alta Pressione	(24")	
<input type="checkbox"/>	Marathon Plus	(24"-25")	01669 65,00
		con protezione anti foratura	
<input type="checkbox"/>	Copertura piena - Colore Grigio	(22")	04181 110,00
<input type="checkbox"/>	Copertura piena - Colore Nero	(24")	11083 110,00
<input type="checkbox"/>	Copertura piena - Colore Grigio	(24")	11083 110,00

Email: info_it@permobil.com - web: http://www.rehateamprogeo.com

Data	Commessa	Utilizzatore	Indirizzo
Cerchi di spinta			
		Distanza ruota <input type="radio"/> 3 cm <input type="checkbox"/> 4 cm	
<input checked="" type="radio"/> Alluminio	(22"-24"-25"-26")		
<input type="radio"/> Alluminio Nero SOFT-TOUCH	(24"-25")	(Corrimano 24", su ruota da 25" viene installato con distanziali)	09170 110,00
<input type="radio"/> Acciaio cromato	(24"-25")	(Corrimano 24", su ruota da 25" viene installato con distanziali)	01684 170,00
<input type="radio"/> Titanio	(24"-25")	(Corrimano 24", su ruota da 25" viene installato con distanziali)	00016 270,00
<input type="radio"/> Ultra Grepp	(24"-25")	(Corrimano 24", su ruota da 25" viene installato con distanziali)	00017 300,00
<input type="radio"/> Max Grepp	(24"-25")	(Corrimano 24", su ruota da 25" viene installato con distanziali)	00834 330,00
<input type="radio"/> Ergo Para	(24")		00632 330,00
<input type="radio"/> TOP FRICTION	(24"-25")	(Corrimano 24", su ruota da 25" viene installato con distanziali)	11023 290,00
Profilo ovale con inserto in gomma			
<input type="radio"/> NOVA H	(24"-25")	(Corrimano 24", su ruota da 25" viene installato con distanziali)	11025 270,00
Profilo ergonomico colore nero			
<input type="radio"/> NOVA D	(24"-25")	(Corrimano 24", su ruota da 25" viene installato con distanziali)	11026 290,00
Profilo ergonomico con rivestimento in gomma (ideale per tetraplegici)			
<input type="radio"/> SURGE LT	(25")	Profilo ovale con inserto in gomma	06427 320,00
<input type="radio"/> Timone (24")	(24")		00693 200,00
<input type="radio"/> Anello anti scivolo in silicone applicabile su cerchio in alluminio		Disponibile per misure da (22" - 24" - 26")	04050 170,00
Freni			
<input checked="" type="radio"/> Freno leva curva da spingere			
<input type="checkbox"/> Freno leva dritta da spingere			
<input type="checkbox"/> Freno leva dritta da tirare			
<input type="radio"/> Freno Sport			06428 110,00
<input type="radio"/> Freno con leva prolungata da spingere			01949 70,00
<input type="radio"/> Freno con leva prolungata da tirare			03372 70,00
Braccioli			
<input type="checkbox"/> Braccioli Tubolari		(Girevoli estraibili regolabili in altezza)	 style="text-align: right;">00694 250,00
<input type="radio"/> Braccioli estraibili con protezione dritta in Carbonio			09079 200,00
Accessori			
<input type="radio"/> Imbottitura paracolpi telaio anteriore			07058 50,00
<input type="radio"/> Patella di raccordo schienale/tela sedile			10241 20,00
<input type="radio"/> Borsello portaoggetti removibile (con aggancio rapido)			09811 120,00
Optional 1			
<u>E' possibile inserire solo un optional per lato</u>			
<input type="radio"/> Ruote ascensore	Esclude l'installazione delle Ruote antiribaltamento		03290 170,00
<input type="radio"/> Ruota antiribaltamento con aggancio rapido	Esclude l'installazione delle Ruote ascensore (rotazione all'interno per ridurre l'ingombro)		
	<input type="radio"/> Destra		06821 130,00
	<input type="radio"/> Sinistra		06822 130,00
Optional 2			
<input type="radio"/> Maniglie di spinta per accompagnatore	(Regolabili in altezza ed estraibili)		03645 190,00
<input type="radio"/> Tetraclip	(perno estrazione rapida per tetraplegici)		03947 170,00
<input type="radio"/> Cinghia pelvica di ancoraggio			03972 70,00
<input type="radio"/> Cinghia di bretellaggio			04103 130,00
<input type="radio"/> Supporto lombare	(da inserire all'interno dello schienale)		00013 50,00
<input type="radio"/> Spinta laterale	<input type="radio"/> Destra		02097 250,00
	<input type="radio"/> Sinistra		02098 250,00
Non disponibile con: Schienale posturale PHYSIO - Schienale posturale A I R			
<input type="radio"/> Copriraggi Nero	(22"-24")		01043 160,00
<input type="radio"/> Copriraggi Trasparente	(22"-24")		00835 160,00
<input type="radio"/> Copriraggi Colorato Progeo Design	(22"-24")		00019 180,00
<input type="radio"/> Copriraggi Dragon	(22"-24")		02106 180,00
Kit aggiuntivo			
<input type="radio"/> Ruote posteriori 24" Fuoristrada	Copertone Fuoristrada - corrimano in alluminio (colore nero)		03378 500,00
<input type="radio"/> Ruote posteriori FAT 24"	Copertone liscio FAT 3" - corrimano in alluminio (colore nero)		09357 850,00

Data Comnessa Utilizzatore Indirizzo

PHYSIO - Schienale posturale
(Imbottitura schienale originale non fornita)

Estraibile con aggancio rapido
Installazione su tubi diametro 18÷26mm
Regolazione in profondità (4cm)
Regolazione inclinazione (±18°)

AIR Guscio CARBONIO
non disponibile per larghezza 48

ALTEZZA SCHIENALE	28	34	40																			
Conformazione del guscio 	Ala di contenimento laterale A=alta - R=regolare																					
	<table border="1"> <thead> <tr> <th>A</th> <th>R</th> <th>A</th> <th>R</th> <th>A</th> <th>R</th> </tr> </thead> <tbody> <tr> <td></td> <td></td> <td></td> <td></td> <td></td> <td></td> </tr> <tr> <td><input type="checkbox"/></td> <td><input type="checkbox"/></td> <td><input type="checkbox"/></td> <td><input type="checkbox"/></td> <td><input type="checkbox"/></td> <td><input type="checkbox"/></td> </tr> </tbody> </table>	A	R	A	R	A	R							<input type="checkbox"/>	<input type="checkbox"/>	<input type="checkbox"/>	<input type="checkbox"/>	<input type="checkbox"/>	<input type="checkbox"/>			
A	R	A	R	A	R																	
<input type="checkbox"/>	<input type="checkbox"/>	<input type="checkbox"/>	<input type="checkbox"/>	<input type="checkbox"/>	<input type="checkbox"/>																	

840,00

POSTURE Guscio ALLUMINIO

ALTEZZA SCHIENALE	34	40	52									
Conformazione del guscio 	Ala di contenimento laterale R=regolare											
	<table border="1"> <thead> <tr> <th>R</th> <th>R</th> <th>R</th> </tr> </thead> <tbody> <tr> <td></td> <td></td> <td></td> </tr> <tr> <td><input type="checkbox"/></td> <td><input type="checkbox"/></td> <td><input type="checkbox"/></td> </tr> </tbody> </table>	R	R	R				<input type="checkbox"/>	<input type="checkbox"/>	<input type="checkbox"/>		
R	R	R										
<input type="checkbox"/>	<input type="checkbox"/>	<input type="checkbox"/>										

810,00

Configurazione DEEP con PAD per contenimento laterale (regolabili in altezza)

Pad in alluminio con imbottitura e rivestimento in tessuto traspirante



Piccolo (h 13cm)



Destro 10272 40,00
 Sinistro 10272 40,00

Grande (h 20cm)



Destro 10273 50,00
 Sinistro 10273 50,00

Supporti toracici (spinta laterale) - SWING AWAY - Girevole

Hardware di fissaggio e regolazione completi di imbottitura paracolpi
Pad in alluminio con imbottitura e rivestimento in tessuto traspirante

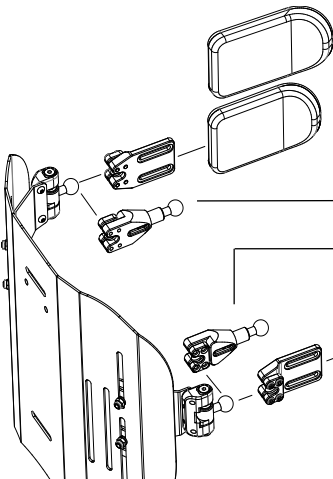

- Grande (18x12) 05647 170,00
- Piccola (14x9) 05643 170,00
- Prolunga supporto toracico
Quantità (n° pz)..... 10271 60,00
- Prolunga supporto toracico
Quantità (n° pz).....
- Piccola (14x9) 05642 170,00
- Grande (18x12) 05646 170,00

Poggiatesta multiregolazione - sistema di montaggio a doppia sfera



Disponibile solo su schienale Physio
Non disponibile su schienale Physio AIR Guscio in Carbonio

Grande (34x14) 05648 360,00
 Piccolo (28x14)





Rehateam s.r.l. Vicolo Negrelli, 5 - 31038 Castagnole di Paese (TV) - Tel. +39.0422.484657/+39.0422.480387 - Fax +39.0422.484661/+39.0422.484684 - P.IVA IT 03182520266 - C.C.I.A.A. TV n.225867 - Iscr.Trib. TV n.4.1690 Capitale Sociale I.V. Euro 100.000,00 la società è soggetta ex art. 2497-bis C.C. al coordinamento e direzione della società "PERMOBIL ITALY SRL" iscritta al Registro Imprese Milano Monza Brianza Lodi 10246110968

Email: info_it@permobil.com - web: http://www.rehateamprogeo.com

Data	Commessa	Utilizzatore	Indirizzo
------------	----------------	--------------------	-----------------

Schienali tensionabili con imbottitura a nido d'ape STIMULITE
 Schienale tensionabile (H imbottitura 41cm)

05173 650,00
Cuscini antidecubito e posturali a nido d'ape STIMULITE

<input type="radio"/> Classic H 7 cm.	<input type="checkbox"/> 36x41	00035	<input type="checkbox"/> 38x38	00036	<input type="checkbox"/> 38x41	01052	<input type="checkbox"/> 41x41	00037		630,00
	<input type="checkbox"/> 41x46	00840	<input type="checkbox"/> 46x41	00698	<input type="checkbox"/> 46x46	00038				
<input type="radio"/> Anatomico Posturale H 10 cm.	<input type="checkbox"/> 36x41	00056	<input type="checkbox"/> 38x38	00696	<input type="checkbox"/> 38x41	00032	<input type="checkbox"/> 41x41	00033		630,00
	<input type="checkbox"/> 41x46	01050	<input type="checkbox"/> 46x41	00034	<input type="checkbox"/> 46x46	01051				
<input type="radio"/> Slimline sagomato H 5 cm.	<input type="checkbox"/> 36x41	00854	<input type="checkbox"/> 38x38	00707	<input type="checkbox"/> 38x41	00083	<input type="checkbox"/> 41x41	01073		630,00
	<input type="checkbox"/> 41x46	00085	<input type="checkbox"/> 46x41	01074	<input type="checkbox"/> 46x46	01075				
<input type="radio"/> Sport H 5 cm.	<input type="checkbox"/> 36x41	00053	<input type="checkbox"/> 38x38	00054	<input type="checkbox"/> 38x41	01060	<input type="checkbox"/> 41x41	01061		600,00
	<input type="checkbox"/> 41x46	00057	<input type="checkbox"/> 46x41	01062	<input type="checkbox"/> 46x46	00846				
<input type="radio"/> Silver H 3,5 cm.	<input type="checkbox"/> 41x41	00641	<input type="checkbox"/> 41x46	01353	<input type="checkbox"/> 46x41	00642	<input type="checkbox"/> 46x46	01022		540,00
Misura cliente Larghezza cm. Profondità cm.										

 Supporto lombare STIMULITE

00064 220,00
 Fodera aggiuntiva al cuscino Silver Plus Cover agli ioni d'argento







04066 180,00

Note

Carrozzina : Progeo DUKE - Rev. 2023.1	Prezzo IVA esclusa da sommare al prezzo di listino	Pagina da inviare se sono stati scelti optional <input checked="" type="checkbox"/> standard (fornito in assenza di altre indicazioni) <input type="checkbox"/> su richiesta (senza aggiunta di prezzo) <input type="checkbox"/> optional (sommare il prezzo a quello di listino)
---	---	--

 Rehateam s.r.l. Vicolo Negrilli, 5 - 31038 Castagnole di Paese (TV) - Tel. +39.0422.484657/+39.0422.480387 - Fax +39.0422.484661/+39.0422.484684 - P.IVA IT 03182520266 - C.C.I.A.A. TV n.41690 Capitale Sociale i.V. Euro 100.000,00
 la società è soggetta ex art. 2497-bis C.C. al coordinamento e direzione della società "PERMOBIL ITALY SRL" iscritta al Registro Imprese Milano Monza Brianza Lodi: 10246110988

Email: info_it@permobil.com - web: http://www.rehateamprogeo.com

Data	Commessa	Utilizzatore	Indirizzo																																																																								
ROHO® MOSAIC® - H7cm - Limite di peso 143Kg 200,00																																																																											
<table border="1"> <thead> <tr> <th>Misure cuscino LxP</th> <th>Adatto a seduta LSxPS</th> <th>Codice</th> </tr> </thead> <tbody> <tr><td><input type="checkbox"/> 41 x 41</td><td>42 x 42</td><td>MOS1616HD</td></tr> <tr><td><input type="checkbox"/> 41 x 46</td><td>42 x 47</td><td>MOS1618HD</td></tr> <tr><td><input type="checkbox"/> 44 x 44</td><td>44 x 44</td><td>MOS1717HD</td></tr> </tbody> </table>	Misure cuscino LxP	Adatto a seduta LSxPS	Codice	<input type="checkbox"/> 41 x 41	42 x 42	MOS1616HD	<input type="checkbox"/> 41 x 46	42 x 47	MOS1618HD	<input type="checkbox"/> 44 x 44	44 x 44	MOS1717HD	<table border="1"> <thead> <tr> <th>Misure cuscino LxP</th> <th>Adatto a seduta LSxPS</th> <th>Codice</th> </tr> </thead> <tbody> <tr><td><input type="checkbox"/> 46 x 41</td><td>47 x 42</td><td>MOS1816HD</td></tr> <tr><td><input type="checkbox"/> 46 x 46</td><td>47 x 47</td><td>MOS1818HD</td></tr> <tr><td><input type="checkbox"/> 51 x 46</td><td>52 x 47</td><td>MOS2018HD</td></tr> </tbody> </table>	Misure cuscino LxP	Adatto a seduta LSxPS	Codice	<input type="checkbox"/> 46 x 41	47 x 42	MOS1816HD	<input type="checkbox"/> 46 x 46	47 x 47	MOS1818HD	<input type="checkbox"/> 51 x 46	52 x 47	MOS2018HD																																																		
Misure cuscino LxP	Adatto a seduta LSxPS	Codice																																																																									
<input type="checkbox"/> 41 x 41	42 x 42	MOS1616HD																																																																									
<input type="checkbox"/> 41 x 46	42 x 47	MOS1618HD																																																																									
<input type="checkbox"/> 44 x 44	44 x 44	MOS1717HD																																																																									
Misure cuscino LxP	Adatto a seduta LSxPS	Codice																																																																									
<input type="checkbox"/> 46 x 41	47 x 42	MOS1816HD																																																																									
<input type="checkbox"/> 46 x 46	47 x 47	MOS1818HD																																																																									
<input type="checkbox"/> 51 x 46	52 x 47	MOS2018HD																																																																									
ROHO® AIR LITE® - H9,5cm - Limite di peso 136Kg 200,00																																																																											
<table border="1"> <thead> <tr> <th>Misure cuscino LxP</th> <th>Codice</th> </tr> </thead> <tbody> <tr><td><input type="checkbox"/> 33 x 33</td><td>AL1313HD</td></tr> <tr><td><input type="checkbox"/> 33 x 38</td><td>AL1315HD</td></tr> <tr><td><input type="checkbox"/> 36 x 36</td><td>AL1414HD</td></tr> <tr><td><input type="checkbox"/> 36 x 41</td><td>AL1416HD</td></tr> <tr><td><input type="checkbox"/> 38 x 38</td><td>AL1515HD</td></tr> <tr><td><input type="checkbox"/> 38 x 43</td><td>AL1517HD</td></tr> <tr><td><input type="checkbox"/> 41 x 41</td><td>AL1616HD</td></tr> <tr><td><input type="checkbox"/> 41 x 46</td><td>AL1618HD</td></tr> <tr><td><input type="checkbox"/> 43 x 43</td><td>AL1717HD</td></tr> </tbody> </table>	Misure cuscino LxP	Codice	<input type="checkbox"/> 33 x 33	AL1313HD	<input type="checkbox"/> 33 x 38	AL1315HD	<input type="checkbox"/> 36 x 36	AL1414HD	<input type="checkbox"/> 36 x 41	AL1416HD	<input type="checkbox"/> 38 x 38	AL1515HD	<input type="checkbox"/> 38 x 43	AL1517HD	<input type="checkbox"/> 41 x 41	AL1616HD	<input type="checkbox"/> 41 x 46	AL1618HD	<input type="checkbox"/> 43 x 43	AL1717HD	<table border="1"> <thead> <tr> <th>Misure cuscino LxP</th> <th>Codice</th> </tr> </thead> <tbody> <tr><td><input type="checkbox"/> 43 x 46</td><td>AL1718HD</td></tr> <tr><td><input type="checkbox"/> 43 x 51</td><td>AL1720HD</td></tr> <tr><td><input type="checkbox"/> 46 x 41</td><td>AL1816HD</td></tr> <tr><td><input type="checkbox"/> 46 x 46</td><td>AL1818HD</td></tr> <tr><td><input type="checkbox"/> 46 x 51</td><td>AL1820HD</td></tr> <tr><td><input type="checkbox"/> 48 x 43</td><td>AL1917HD</td></tr> <tr><td><input type="checkbox"/> 48 x 48</td><td>AL1919HD</td></tr> <tr><td><input type="checkbox"/> 51 x 43</td><td>AL2017HD</td></tr> <tr><td><input type="checkbox"/> 51 x 46</td><td>AL2018HD</td></tr> </tbody> </table>	Misure cuscino LxP	Codice	<input type="checkbox"/> 43 x 46	AL1718HD	<input type="checkbox"/> 43 x 51	AL1720HD	<input type="checkbox"/> 46 x 41	AL1816HD	<input type="checkbox"/> 46 x 46	AL1818HD	<input type="checkbox"/> 46 x 51	AL1820HD	<input type="checkbox"/> 48 x 43	AL1917HD	<input type="checkbox"/> 48 x 48	AL1919HD	<input type="checkbox"/> 51 x 43	AL2017HD	<input type="checkbox"/> 51 x 46	AL2018HD																																		
Misure cuscino LxP	Codice																																																																										
<input type="checkbox"/> 33 x 33	AL1313HD																																																																										
<input type="checkbox"/> 33 x 38	AL1315HD																																																																										
<input type="checkbox"/> 36 x 36	AL1414HD																																																																										
<input type="checkbox"/> 36 x 41	AL1416HD																																																																										
<input type="checkbox"/> 38 x 38	AL1515HD																																																																										
<input type="checkbox"/> 38 x 43	AL1517HD																																																																										
<input type="checkbox"/> 41 x 41	AL1616HD																																																																										
<input type="checkbox"/> 41 x 46	AL1618HD																																																																										
<input type="checkbox"/> 43 x 43	AL1717HD																																																																										
Misure cuscino LxP	Codice																																																																										
<input type="checkbox"/> 43 x 46	AL1718HD																																																																										
<input type="checkbox"/> 43 x 51	AL1720HD																																																																										
<input type="checkbox"/> 46 x 41	AL1816HD																																																																										
<input type="checkbox"/> 46 x 46	AL1818HD																																																																										
<input type="checkbox"/> 46 x 51	AL1820HD																																																																										
<input type="checkbox"/> 48 x 43	AL1917HD																																																																										
<input type="checkbox"/> 48 x 48	AL1919HD																																																																										
<input type="checkbox"/> 51 x 43	AL2017HD																																																																										
<input type="checkbox"/> 51 x 46	AL2018HD																																																																										
ROHO® HYBRID ELITE SR® - Monovalvola - Sensor Ready - Limite di peso 225Kg 630,00																																																																											
<table border="1"> <thead> <tr> <th>Misure cuscino LxP</th> <th>Adatto a seduta LSxPS</th> <th>Codice</th> </tr> </thead> <tbody> <tr><td><input type="checkbox"/> 35 x 37,5</td><td>36 x 36</td><td>1RHE1414C-SR</td></tr> <tr><td><input type="checkbox"/> 35 x 40</td><td>36 x 38</td><td>1RHE1415C-SR</td></tr> <tr><td><input type="checkbox"/> 35 x 43</td><td>36 x 41</td><td>1RHE1416C-SR</td></tr> <tr><td><input type="checkbox"/> 37,5 x 40</td><td>38 x 38</td><td>1RHE1515C-SR</td></tr> <tr><td><input type="checkbox"/> 37,5 x 43</td><td>38 x 41</td><td>1RHE1516C-SR</td></tr> <tr><td><input type="checkbox"/> 37,5 x 45</td><td>38 x 43</td><td>1RHE1517C-SR</td></tr> <tr><td><input type="checkbox"/> 40 x 40</td><td>41 x 38</td><td>1RHE1615C-SR</td></tr> <tr><td><input type="checkbox"/> 40 x 43</td><td>41 x 41</td><td>1RHE1616C-SR</td></tr> <tr><td><input type="checkbox"/> 40 x 45</td><td>41 x 43</td><td>1RHE1617C-SR</td></tr> <tr><td><input type="checkbox"/> 40 x 48</td><td>41 x 46</td><td>1RHE1618C-SR</td></tr> <tr><td><input type="checkbox"/> 40 x 53</td><td>41 x 51</td><td>1RHE1620C-SR</td></tr> </tbody> </table>	Misure cuscino LxP	Adatto a seduta LSxPS	Codice	<input type="checkbox"/> 35 x 37,5	36 x 36	1RHE1414C-SR	<input type="checkbox"/> 35 x 40	36 x 38	1RHE1415C-SR	<input type="checkbox"/> 35 x 43	36 x 41	1RHE1416C-SR	<input type="checkbox"/> 37,5 x 40	38 x 38	1RHE1515C-SR	<input type="checkbox"/> 37,5 x 43	38 x 41	1RHE1516C-SR	<input type="checkbox"/> 37,5 x 45	38 x 43	1RHE1517C-SR	<input type="checkbox"/> 40 x 40	41 x 38	1RHE1615C-SR	<input type="checkbox"/> 40 x 43	41 x 41	1RHE1616C-SR	<input type="checkbox"/> 40 x 45	41 x 43	1RHE1617C-SR	<input type="checkbox"/> 40 x 48	41 x 46	1RHE1618C-SR	<input type="checkbox"/> 40 x 53	41 x 51	1RHE1620C-SR	<table border="1"> <thead> <tr> <th>Misure cuscino LxP</th> <th>Adatto a seduta LSxPS</th> <th>Codice</th> </tr> </thead> <tbody> <tr><td><input type="checkbox"/> 43 x 43</td><td>43 x 41</td><td>1RHE1716C-SR</td></tr> <tr><td><input type="checkbox"/> 43 x 45</td><td>43 x 43</td><td>1RHE1717C-SR</td></tr> <tr><td><input type="checkbox"/> 43 x 48</td><td>43 x 46</td><td>1RHE1718C-SR</td></tr> <tr><td><input type="checkbox"/> 43 x 53</td><td>43 x 51</td><td>1RHE1720C-SR</td></tr> <tr><td><input type="checkbox"/> 45 x 43</td><td>46 x 41</td><td>1RHE1816C-SR</td></tr> <tr><td><input type="checkbox"/> 45 x 45</td><td>46 x 43</td><td>1RHE1817C-SR</td></tr> <tr><td><input type="checkbox"/> 45 x 48</td><td>46 x 46</td><td>1RHE1818C-SR</td></tr> <tr><td><input type="checkbox"/> 45 x 53</td><td>46 x 51</td><td>1RHE1820C-SR</td></tr> <tr><td><input type="checkbox"/> 50 x 45</td><td>51 x 43</td><td>1RHE2017C-SR</td></tr> <tr><td><input type="checkbox"/> 50 x 48</td><td>51 x 46</td><td>1RHE2018C-SR</td></tr> <tr><td><input type="checkbox"/> 50 x 53</td><td>51 x 51</td><td>1RHE2020C-SR</td></tr> </tbody> </table>	Misure cuscino LxP	Adatto a seduta LSxPS	Codice	<input type="checkbox"/> 43 x 43	43 x 41	1RHE1716C-SR	<input type="checkbox"/> 43 x 45	43 x 43	1RHE1717C-SR	<input type="checkbox"/> 43 x 48	43 x 46	1RHE1718C-SR	<input type="checkbox"/> 43 x 53	43 x 51	1RHE1720C-SR	<input type="checkbox"/> 45 x 43	46 x 41	1RHE1816C-SR	<input type="checkbox"/> 45 x 45	46 x 43	1RHE1817C-SR	<input type="checkbox"/> 45 x 48	46 x 46	1RHE1818C-SR	<input type="checkbox"/> 45 x 53	46 x 51	1RHE1820C-SR	<input type="checkbox"/> 50 x 45	51 x 43	1RHE2017C-SR	<input type="checkbox"/> 50 x 48	51 x 46	1RHE2018C-SR	<input type="checkbox"/> 50 x 53	51 x 51	1RHE2020C-SR		
Misure cuscino LxP	Adatto a seduta LSxPS	Codice																																																																									
<input type="checkbox"/> 35 x 37,5	36 x 36	1RHE1414C-SR																																																																									
<input type="checkbox"/> 35 x 40	36 x 38	1RHE1415C-SR																																																																									
<input type="checkbox"/> 35 x 43	36 x 41	1RHE1416C-SR																																																																									
<input type="checkbox"/> 37,5 x 40	38 x 38	1RHE1515C-SR																																																																									
<input type="checkbox"/> 37,5 x 43	38 x 41	1RHE1516C-SR																																																																									
<input type="checkbox"/> 37,5 x 45	38 x 43	1RHE1517C-SR																																																																									
<input type="checkbox"/> 40 x 40	41 x 38	1RHE1615C-SR																																																																									
<input type="checkbox"/> 40 x 43	41 x 41	1RHE1616C-SR																																																																									
<input type="checkbox"/> 40 x 45	41 x 43	1RHE1617C-SR																																																																									
<input type="checkbox"/> 40 x 48	41 x 46	1RHE1618C-SR																																																																									
<input type="checkbox"/> 40 x 53	41 x 51	1RHE1620C-SR																																																																									
Misure cuscino LxP	Adatto a seduta LSxPS	Codice																																																																									
<input type="checkbox"/> 43 x 43	43 x 41	1RHE1716C-SR																																																																									
<input type="checkbox"/> 43 x 45	43 x 43	1RHE1717C-SR																																																																									
<input type="checkbox"/> 43 x 48	43 x 46	1RHE1718C-SR																																																																									
<input type="checkbox"/> 43 x 53	43 x 51	1RHE1720C-SR																																																																									
<input type="checkbox"/> 45 x 43	46 x 41	1RHE1816C-SR																																																																									
<input type="checkbox"/> 45 x 45	46 x 43	1RHE1817C-SR																																																																									
<input type="checkbox"/> 45 x 48	46 x 46	1RHE1818C-SR																																																																									
<input type="checkbox"/> 45 x 53	46 x 51	1RHE1820C-SR																																																																									
<input type="checkbox"/> 50 x 45	51 x 43	1RHE2017C-SR																																																																									
<input type="checkbox"/> 50 x 48	51 x 46	1RHE2018C-SR																																																																									
<input type="checkbox"/> 50 x 53	51 x 51	1RHE2020C-SR																																																																									
ROHO® HYBRID ELITE® - Bivalvola /Bicompartimento - Limite di peso 225Kg 630,00																																																																											
<table border="1"> <thead> <tr> <th>Misure cuscino LxP</th> <th>Adatto a seduta LSxPS</th> <th>Codice</th> </tr> </thead> <tbody> <tr><td><input type="checkbox"/> 35 x 37,5</td><td>36 x 36</td><td>2RHE1414C</td></tr> <tr><td><input type="checkbox"/> 35 x 40</td><td>36 x 38</td><td>2RHE1415C</td></tr> <tr><td><input type="checkbox"/> 35 x 43</td><td>36 x 41</td><td>2RHE1416C</td></tr> <tr><td><input type="checkbox"/> 37,5 x 40</td><td>38 x 38</td><td>2RHE1515C</td></tr> <tr><td><input type="checkbox"/> 37,5 x 43</td><td>38 x 41</td><td>2RHE1516C</td></tr> <tr><td><input type="checkbox"/> 37,5 x 45</td><td>38 x 43</td><td>2RHE1517C</td></tr> <tr><td><input type="checkbox"/> 40 x 40</td><td>41 x 38</td><td>2RHE1615C</td></tr> <tr><td><input type="checkbox"/> 40 x 43</td><td>41 x 41</td><td>2RHE1616C</td></tr> <tr><td><input type="checkbox"/> 40 x 45</td><td>41 x 43</td><td>2RHE1617C</td></tr> <tr><td><input type="checkbox"/> 40 x 48</td><td>41 x 46</td><td>2RHE1618C</td></tr> <tr><td><input type="checkbox"/> 40 x 53</td><td>41 x 51</td><td>2RHE1620C</td></tr> </tbody> </table>	Misure cuscino LxP	Adatto a seduta LSxPS	Codice	<input type="checkbox"/> 35 x 37,5	36 x 36	2RHE1414C	<input type="checkbox"/> 35 x 40	36 x 38	2RHE1415C	<input type="checkbox"/> 35 x 43	36 x 41	2RHE1416C	<input type="checkbox"/> 37,5 x 40	38 x 38	2RHE1515C	<input type="checkbox"/> 37,5 x 43	38 x 41	2RHE1516C	<input type="checkbox"/> 37,5 x 45	38 x 43	2RHE1517C	<input type="checkbox"/> 40 x 40	41 x 38	2RHE1615C	<input type="checkbox"/> 40 x 43	41 x 41	2RHE1616C	<input type="checkbox"/> 40 x 45	41 x 43	2RHE1617C	<input type="checkbox"/> 40 x 48	41 x 46	2RHE1618C	<input type="checkbox"/> 40 x 53	41 x 51	2RHE1620C	<table border="1"> <thead> <tr> <th>Misure cuscino LxP</th> <th>Adatto a seduta LSxPS</th> <th>Codice</th> </tr> </thead> <tbody> <tr><td><input type="checkbox"/> 43 x 43</td><td>43 x 41</td><td>2RHE1716C</td></tr> <tr><td><input type="checkbox"/> 43 x 45</td><td>43 x 43</td><td>2RHE1717C</td></tr> <tr><td><input type="checkbox"/> 43 x 48</td><td>43 x 46</td><td>2RHE1718C</td></tr> <tr><td><input type="checkbox"/> 43 x 53</td><td>43 x 51</td><td>2RHE1720C</td></tr> <tr><td><input type="checkbox"/> 45 x 43</td><td>46 x 41</td><td>2RHE1816C</td></tr> <tr><td><input type="checkbox"/> 45 x 45</td><td>46 x 43</td><td>2RHE1817C</td></tr> <tr><td><input type="checkbox"/> 45 x 48</td><td>46 x 46</td><td>2RHE1818C</td></tr> <tr><td><input type="checkbox"/> 45 x 53</td><td>46 x 51</td><td>2RHE1820C</td></tr> <tr><td><input type="checkbox"/> 50 x 45</td><td>51 x 43</td><td>2RHE2017C</td></tr> <tr><td><input type="checkbox"/> 50 x 48</td><td>51 x 46</td><td>2RHE2018C</td></tr> <tr><td><input type="checkbox"/> 50 x 53</td><td>51 x 51</td><td>2RHE2020C</td></tr> </tbody> </table>	Misure cuscino LxP	Adatto a seduta LSxPS	Codice	<input type="checkbox"/> 43 x 43	43 x 41	2RHE1716C	<input type="checkbox"/> 43 x 45	43 x 43	2RHE1717C	<input type="checkbox"/> 43 x 48	43 x 46	2RHE1718C	<input type="checkbox"/> 43 x 53	43 x 51	2RHE1720C	<input type="checkbox"/> 45 x 43	46 x 41	2RHE1816C	<input type="checkbox"/> 45 x 45	46 x 43	2RHE1817C	<input type="checkbox"/> 45 x 48	46 x 46	2RHE1818C	<input type="checkbox"/> 45 x 53	46 x 51	2RHE1820C	<input type="checkbox"/> 50 x 45	51 x 43	2RHE2017C	<input type="checkbox"/> 50 x 48	51 x 46	2RHE2018C	<input type="checkbox"/> 50 x 53	51 x 51	2RHE2020C		
Misure cuscino LxP	Adatto a seduta LSxPS	Codice																																																																									
<input type="checkbox"/> 35 x 37,5	36 x 36	2RHE1414C																																																																									
<input type="checkbox"/> 35 x 40	36 x 38	2RHE1415C																																																																									
<input type="checkbox"/> 35 x 43	36 x 41	2RHE1416C																																																																									
<input type="checkbox"/> 37,5 x 40	38 x 38	2RHE1515C																																																																									
<input type="checkbox"/> 37,5 x 43	38 x 41	2RHE1516C																																																																									
<input type="checkbox"/> 37,5 x 45	38 x 43	2RHE1517C																																																																									
<input type="checkbox"/> 40 x 40	41 x 38	2RHE1615C																																																																									
<input type="checkbox"/> 40 x 43	41 x 41	2RHE1616C																																																																									
<input type="checkbox"/> 40 x 45	41 x 43	2RHE1617C																																																																									
<input type="checkbox"/> 40 x 48	41 x 46	2RHE1618C																																																																									
<input type="checkbox"/> 40 x 53	41 x 51	2RHE1620C																																																																									
Misure cuscino LxP	Adatto a seduta LSxPS	Codice																																																																									
<input type="checkbox"/> 43 x 43	43 x 41	2RHE1716C																																																																									
<input type="checkbox"/> 43 x 45	43 x 43	2RHE1717C																																																																									
<input type="checkbox"/> 43 x 48	43 x 46	2RHE1718C																																																																									
<input type="checkbox"/> 43 x 53	43 x 51	2RHE1720C																																																																									
<input type="checkbox"/> 45 x 43	46 x 41	2RHE1816C																																																																									
<input type="checkbox"/> 45 x 45	46 x 43	2RHE1817C																																																																									
<input type="checkbox"/> 45 x 48	46 x 46	2RHE1818C																																																																									
<input type="checkbox"/> 45 x 53	46 x 51	2RHE1820C																																																																									
<input type="checkbox"/> 50 x 45	51 x 43	2RHE2017C																																																																									
<input type="checkbox"/> 50 x 48	51 x 46	2RHE2018C																																																																									
<input type="checkbox"/> 50 x 53	51 x 51	2RHE2020C																																																																									
ROHO® HYBRID SELECT® 630,00																																																																											
<table border="1"> <thead> <tr> <th>Misure cuscino LxP</th> <th>Adatto a seduta LSxPS</th> <th>Codice</th> </tr> </thead> <tbody> <tr><td><input type="checkbox"/> 35,5 x 37,5</td><td>36x38</td><td>HS1414C</td></tr> <tr><td><input type="checkbox"/> 35,5 x 42,5</td><td>36x43</td><td>HS1416C</td></tr> <tr><td><input type="checkbox"/> 38 x 40</td><td>38x40</td><td>HS1515C</td></tr> <tr><td><input type="checkbox"/> 38 x 42,5</td><td>38x43</td><td>HS1516C</td></tr> <tr><td><input type="checkbox"/> 38 x 45</td><td>38x45</td><td>HS1517C</td></tr> <tr><td><input type="checkbox"/> 40,5 x 40</td><td>41x40</td><td>HS1615C</td></tr> <tr><td><input type="checkbox"/> 40,5 x 42,5</td><td>41x43</td><td>HS1616C</td></tr> <tr><td><input type="checkbox"/> 40,5 x 45</td><td>41x45</td><td>HS1617C</td></tr> <tr><td><input type="checkbox"/> 40,5 x 47,5</td><td>41x48</td><td>HS1618C</td></tr> <tr><td><input type="checkbox"/> 40,5 x 52,5</td><td>41x53</td><td>HS1620C</td></tr> <tr><td><input type="checkbox"/> 43 x 42,5</td><td>43x43</td><td>HS1716C</td></tr> </tbody> </table>	Misure cuscino LxP	Adatto a seduta LSxPS	Codice	<input type="checkbox"/> 35,5 x 37,5	36x38	HS1414C	<input type="checkbox"/> 35,5 x 42,5	36x43	HS1416C	<input type="checkbox"/> 38 x 40	38x40	HS1515C	<input type="checkbox"/> 38 x 42,5	38x43	HS1516C	<input type="checkbox"/> 38 x 45	38x45	HS1517C	<input type="checkbox"/> 40,5 x 40	41x40	HS1615C	<input type="checkbox"/> 40,5 x 42,5	41x43	HS1616C	<input type="checkbox"/> 40,5 x 45	41x45	HS1617C	<input type="checkbox"/> 40,5 x 47,5	41x48	HS1618C	<input type="checkbox"/> 40,5 x 52,5	41x53	HS1620C	<input type="checkbox"/> 43 x 42,5	43x43	HS1716C	<table border="1"> <thead> <tr> <th>Misure cuscino LxP</th> <th>Adatto a seduta LSxPS</th> <th>Codice</th> </tr> </thead> <tbody> <tr><td><input type="checkbox"/> 43 x 45</td><td>43x45</td><td>HS1717C</td></tr> <tr><td><input type="checkbox"/> 43 x 47,5</td><td>43x48</td><td>HS1718C</td></tr> <tr><td><input type="checkbox"/> 43 x 52,5</td><td>43x53</td><td>HS1720C</td></tr> <tr><td><input type="checkbox"/> 45,5 x 42,5</td><td>46x43</td><td>HS1816C</td></tr> <tr><td><input type="checkbox"/> 45,5 x 45</td><td>46x45</td><td>HS1817C</td></tr> <tr><td><input type="checkbox"/> 45,5 x 47,5</td><td>46x48</td><td>HS1818C</td></tr> <tr><td><input type="checkbox"/> 45,5 x 52,5</td><td>46x53</td><td>HS1820C</td></tr> <tr><td><input type="checkbox"/> 51 x 42,5</td><td>51x43</td><td>HS2016C</td></tr> <tr><td><input type="checkbox"/> 51 x 45</td><td>51x45</td><td>HS2017C</td></tr> <tr><td><input type="checkbox"/> 51 x 47,5</td><td>51x48</td><td>HS2018C</td></tr> <tr><td><input type="checkbox"/> 51 x 52,5</td><td>51x53</td><td>HS2020C</td></tr> </tbody> </table>	Misure cuscino LxP	Adatto a seduta LSxPS	Codice	<input type="checkbox"/> 43 x 45	43x45	HS1717C	<input type="checkbox"/> 43 x 47,5	43x48	HS1718C	<input type="checkbox"/> 43 x 52,5	43x53	HS1720C	<input type="checkbox"/> 45,5 x 42,5	46x43	HS1816C	<input type="checkbox"/> 45,5 x 45	46x45	HS1817C	<input type="checkbox"/> 45,5 x 47,5	46x48	HS1818C	<input type="checkbox"/> 45,5 x 52,5	46x53	HS1820C	<input type="checkbox"/> 51 x 42,5	51x43	HS2016C	<input type="checkbox"/> 51 x 45	51x45	HS2017C	<input type="checkbox"/> 51 x 47,5	51x48	HS2018C	<input type="checkbox"/> 51 x 52,5	51x53	HS2020C		
Misure cuscino LxP	Adatto a seduta LSxPS	Codice																																																																									
<input type="checkbox"/> 35,5 x 37,5	36x38	HS1414C																																																																									
<input type="checkbox"/> 35,5 x 42,5	36x43	HS1416C																																																																									
<input type="checkbox"/> 38 x 40	38x40	HS1515C																																																																									
<input type="checkbox"/> 38 x 42,5	38x43	HS1516C																																																																									
<input type="checkbox"/> 38 x 45	38x45	HS1517C																																																																									
<input type="checkbox"/> 40,5 x 40	41x40	HS1615C																																																																									
<input type="checkbox"/> 40,5 x 42,5	41x43	HS1616C																																																																									
<input type="checkbox"/> 40,5 x 45	41x45	HS1617C																																																																									
<input type="checkbox"/> 40,5 x 47,5	41x48	HS1618C																																																																									
<input type="checkbox"/> 40,5 x 52,5	41x53	HS1620C																																																																									
<input type="checkbox"/> 43 x 42,5	43x43	HS1716C																																																																									
Misure cuscino LxP	Adatto a seduta LSxPS	Codice																																																																									
<input type="checkbox"/> 43 x 45	43x45	HS1717C																																																																									
<input type="checkbox"/> 43 x 47,5	43x48	HS1718C																																																																									
<input type="checkbox"/> 43 x 52,5	43x53	HS1720C																																																																									
<input type="checkbox"/> 45,5 x 42,5	46x43	HS1816C																																																																									
<input type="checkbox"/> 45,5 x 45	46x45	HS1817C																																																																									
<input type="checkbox"/> 45,5 x 47,5	46x48	HS1818C																																																																									
<input type="checkbox"/> 45,5 x 52,5	46x53	HS1820C																																																																									
<input type="checkbox"/> 51 x 42,5	51x43	HS2016C																																																																									
<input type="checkbox"/> 51 x 45	51x45	HS2017C																																																																									
<input type="checkbox"/> 51 x 47,5	51x48	HS2018C																																																																									
<input type="checkbox"/> 51 x 52,5	51x53	HS2020C																																																																									
ROHO® MONOCOMPARTIMENT® High Profile® altezza 10 cm 335,00																																																																											
<table border="1"> <thead> <tr> <th>Misure cuscino LxP</th> <th>Adatto a seduta LSxPS</th> <th>Codice</th> </tr> </thead> <tbody> <tr><td><input type="checkbox"/> 30 x 30 - (6 x 6)</td><td>26,5+31 x 26,5+31</td><td>1R66C</td></tr> <tr><td><input type="checkbox"/> 30 x 33 - (6 x 7)</td><td>26,5+31 x 31+35</td><td>1R67C</td></tr> <tr><td><input type="checkbox"/> 33 x 33 - (7 x 7)</td><td>31+35 x 31+35</td><td>1R77C</td></tr> <tr><td><input type="checkbox"/> 33 x 38 - (7 x 8)</td><td>31+35 x 35+39,5</td><td>1R78C</td></tr> <tr><td><input type="checkbox"/> 33 x 42 - (7 x 9)</td><td>31+35 x 39,5+44</td><td>1R79C</td></tr> <tr><td><input type="checkbox"/> 38 x 33 - (8 x 7)</td><td>35+39,5 x 31+35</td><td>1R87C</td></tr> <tr><td><input type="checkbox"/> 38 x 38 - (8 x 8)</td><td>35+39,5 x 35+39,5</td><td>1R88C</td></tr> <tr><td><input type="checkbox"/> 38 x 42 - (8 x 9)</td><td>35+39,5 x 39,5+44</td><td>1R89C</td></tr> <tr><td><input type="checkbox"/> 38 x 46 - (8 x 10)</td><td>35+39,5 x 44+48,5</td><td>1R810C</td></tr> <tr><td><input type="checkbox"/> 42 x 38 - (9 x 8)</td><td>39,5+44 x 35+39,5</td><td>1R98C</td></tr> <tr><td><input type="checkbox"/> 42 x 42 - (9 x 9)</td><td>39,5+44 x 39,5+44</td><td>1R99C</td></tr> </tbody> </table>	Misure cuscino LxP	Adatto a seduta LSxPS	Codice	<input type="checkbox"/> 30 x 30 - (6 x 6)	26,5+31 x 26,5+31	1R66C	<input type="checkbox"/> 30 x 33 - (6 x 7)	26,5+31 x 31+35	1R67C	<input type="checkbox"/> 33 x 33 - (7 x 7)	31+35 x 31+35	1R77C	<input type="checkbox"/> 33 x 38 - (7 x 8)	31+35 x 35+39,5	1R78C	<input type="checkbox"/> 33 x 42 - (7 x 9)	31+35 x 39,5+44	1R79C	<input type="checkbox"/> 38 x 33 - (8 x 7)	35+39,5 x 31+35	1R87C	<input type="checkbox"/> 38 x 38 - (8 x 8)	35+39,5 x 35+39,5	1R88C	<input type="checkbox"/> 38 x 42 - (8 x 9)	35+39,5 x 39,5+44	1R89C	<input type="checkbox"/> 38 x 46 - (8 x 10)	35+39,5 x 44+48,5	1R810C	<input type="checkbox"/> 42 x 38 - (9 x 8)	39,5+44 x 35+39,5	1R98C	<input type="checkbox"/> 42 x 42 - (9 x 9)	39,5+44 x 39,5+44	1R99C	<table border="1"> <thead> <tr> <th>Misure cuscino LxP</th> <th>Adatto a seduta LSxPS</th> <th>Codice</th> </tr> </thead> <tbody> <tr><td><input type="checkbox"/> 42 x 46 - (9 x 10)</td><td>39,5+44 x 44+48,5</td><td>1R910C</td></tr> <tr><td><input type="checkbox"/> 42 x 51 - (9 x 11)</td><td>39,5+44 x 48,5+52,5</td><td>1R911C</td></tr> <tr><td><input type="checkbox"/> 46 x 38 - (10 x 8)</td><td>44+48,5 x 35+39,5</td><td>1R108C</td></tr> <tr><td><input type="checkbox"/> 46 x 42 - (10 x 9)</td><td>44+48,5 x 39,5+44</td><td>1R109C</td></tr> <tr><td><input type="checkbox"/> 46 x 46 - (10 x 10)</td><td>44+48,5 x 44+48,5</td><td>1R1010C</td></tr> <tr><td><input type="checkbox"/> 46 x 51 - (10 x 11)</td><td>44+48,5 x 48,5+52,5</td><td>1R1011C</td></tr> <tr><td><input type="checkbox"/> 46 x 56 - (10 x 12)</td><td>44+48,5 x 52,5+57</td><td>1R1012C</td></tr> <tr><td><input type="checkbox"/> 51 x 42 - (11 x 9)</td><td>48,5+52,5 x 39,5+44</td><td>1R119C</td></tr> <tr><td><input type="checkbox"/> 51 x 46 - (11 x 10)</td><td>48,5+52,5 x 44+48,5</td><td>1R1110C</td></tr> <tr><td><input type="checkbox"/> 51 x 51 - (11 x 11)</td><td>48,5+52,5 x 48,5+52,5</td><td>1R1111C</td></tr> <tr><td><input type="checkbox"/> 51 x 56 - (11 x 12)</td><td>48,5+52,5 x 52,5+57</td><td>1R1112C</td></tr> </tbody> </table>	Misure cuscino LxP	Adatto a seduta LSxPS	Codice	<input type="checkbox"/> 42 x 46 - (9 x 10)	39,5+44 x 44+48,5	1R910C	<input type="checkbox"/> 42 x 51 - (9 x 11)	39,5+44 x 48,5+52,5	1R911C	<input type="checkbox"/> 46 x 38 - (10 x 8)	44+48,5 x 35+39,5	1R108C	<input type="checkbox"/> 46 x 42 - (10 x 9)	44+48,5 x 39,5+44	1R109C	<input type="checkbox"/> 46 x 46 - (10 x 10)	44+48,5 x 44+48,5	1R1010C	<input type="checkbox"/> 46 x 51 - (10 x 11)	44+48,5 x 48,5+52,5	1R1011C	<input type="checkbox"/> 46 x 56 - (10 x 12)	44+48,5 x 52,5+57	1R1012C	<input type="checkbox"/> 51 x 42 - (11 x 9)	48,5+52,5 x 39,5+44	1R119C	<input type="checkbox"/> 51 x 46 - (11 x 10)	48,5+52,5 x 44+48,5	1R1110C	<input type="checkbox"/> 51 x 51 - (11 x 11)	48,5+52,5 x 48,5+52,5	1R1111C	<input type="checkbox"/> 51 x 56 - (11 x 12)	48,5+52,5 x 52,5+57	1R1112C		
Misure cuscino LxP	Adatto a seduta LSxPS	Codice																																																																									
<input type="checkbox"/> 30 x 30 - (6 x 6)	26,5+31 x 26,5+31	1R66C																																																																									
<input type="checkbox"/> 30 x 33 - (6 x 7)	26,5+31 x 31+35	1R67C																																																																									
<input type="checkbox"/> 33 x 33 - (7 x 7)	31+35 x 31+35	1R77C																																																																									
<input type="checkbox"/> 33 x 38 - (7 x 8)	31+35 x 35+39,5	1R78C																																																																									
<input type="checkbox"/> 33 x 42 - (7 x 9)	31+35 x 39,5+44	1R79C																																																																									
<input type="checkbox"/> 38 x 33 - (8 x 7)	35+39,5 x 31+35	1R87C																																																																									
<input type="checkbox"/> 38 x 38 - (8 x 8)	35+39,5 x 35+39,5	1R88C																																																																									
<input type="checkbox"/> 38 x 42 - (8 x 9)	35+39,5 x 39,5+44	1R89C																																																																									
<input type="checkbox"/> 38 x 46 - (8 x 10)	35+39,5 x 44+48,5	1R810C																																																																									
<input type="checkbox"/> 42 x 38 - (9 x 8)	39,5+44 x 35+39,5	1R98C																																																																									
<input type="checkbox"/> 42 x 42 - (9 x 9)	39,5+44 x 39,5+44	1R99C																																																																									
Misure cuscino LxP	Adatto a seduta LSxPS	Codice																																																																									
<input type="checkbox"/> 42 x 46 - (9 x 10)	39,5+44 x 44+48,5	1R910C																																																																									
<input type="checkbox"/> 42 x 51 - (9 x 11)	39,5+44 x 48,5+52,5	1R911C																																																																									
<input type="checkbox"/> 46 x 38 - (10 x 8)	44+48,5 x 35+39,5	1R108C																																																																									
<input type="checkbox"/> 46 x 42 - (10 x 9)	44+48,5 x 39,5+44	1R109C																																																																									
<input type="checkbox"/> 46 x 46 - (10 x 10)	44+48,5 x 44+48,5	1R1010C																																																																									
<input type="checkbox"/> 46 x 51 - (10 x 11)	44+48,5 x 48,5+52,5	1R1011C																																																																									
<input type="checkbox"/> 46 x 56 - (10 x 12)	44+48,5 x 52,5+57	1R1012C																																																																									
<input type="checkbox"/> 51 x 42 - (11 x 9)	48,5+52,5 x 39,5+44	1R119C																																																																									
<input type="checkbox"/> 51 x 46 - (11 x 10)	48,5+52,5 x 44+48,5	1R1110C																																																																									
<input type="checkbox"/> 51 x 51 - (11 x 11)	48,5+52,5 x 48,5+52,5	1R1111C																																																																									
<input type="checkbox"/> 51 x 56 - (11 x 12)	48,5+52,5 x 52,5+57	1R1112C																																																																									

Data	Commessa	Utilizzatore	Indirizzo
------	----------	--------------	-----------

O ROHO® MONOCOMPARTIMENT® Low Profile® altezza 5 cm **335,00**

Misure cuscino LxP	Adatto a seduta LSxPS	Codice	Misure cuscino LxP	Adatto a seduta LSxPS	Codice
□ 30 x 30 - (6 x 6)	26,5+31 x 26,5+31	1R66LPC	□ 42 x 42 - (9 x 9)	39,5+44 x 39,5+44	1R99LPC
□ 30 x 33 - (6 x 7)	26,5+31 x 31+35	1R67LPC	□ 42 x 46 - (9 x 10)	39,5+44 x 44+48,5	1R910LPC
□ 33 x 33 - (7 x 7)	31+35 x 31+35	1R77LPC	□ 42 x 51 - (9 x 11)	39,5+44 x 48,5+52,5	1R911LPC
□ 33 x 38 - (7 x 8)	31+35 x 35+39,5	1R78LPC	□ 46 x 38 - (10 x 8)	44+48,5 x 35+39,5	1R108LPC
□ 33 x 42 - (7 x 9)	31+35 x 39,5+44	1R79LPC	□ 46 x 42 - (10 x 9)	44+48,5 x 39,5+44	1R109LPC
□ 38 x 33 - (8 x 7)	35+39,5 x 31+35	1R87LPC	□ 46 x 46 - (10 x 10)	44+48,5 x 44+48,5	1R1010LPC
□ 38 x 38 - (8 x 8)	35+39,5 x 35+39,5	1R88LPC	□ 46 x 51 - (10 x 11)	44+48,5 x 48,5+52,5	1R1011LPC
□ 38 x 42 - (8 x 9)	35+39,5 x 39,5+44	1R89LPC	□ 51 x 42 - (11 x 9)	48,5+52,5 x 39,5+44	1R119LPC
□ 38 x 46 - (8 x 10)	35+39,5 x 44+48,5	1R810LPC	□ 51 x 46 - (11 x 10)	48,5+52,5 x 44+48,5	1R1110LPC
□ 42 x 38 - (9 x 8)	39,5+44 x 35+39,5	1R98LPC	□ 51 x 51 - (11 x 11)	48,5+52,5 x 48,5+52,5	1R1111LPC



O ROHO® QUADTRO SELECT® High Profile® altezza 10 cm **630,00**

Misure cuscino LxP	Adatto a seduta LSxPS	Codice	Misure cuscino LxP	Adatto a seduta LSxPS	Codice
□ 30 x 30 - (6 x 6)	26,5+31 x 26,5+31	QS66C	□ 42 x 46 - (9 x 10)	39,5+44 x 44+48,5	QS910C
□ 30 x 33 - (6 x 7)	26,5+31 x 31+35	QS67C	□ 42 x 51 - (9 x 11)	39,5+44 x 48,5+52,5	QS911C
□ 33 x 33 - (7 x 7)	31+35 x 31+35	QS77C	□ 42 x 56 - (9 x 12)	39,5+44 x 52,5+57	QS912C
□ 33 x 38 - (7 x 8)	31+35 x 35+39,5	QS78C	□ 46 x 38 - (10 x 8)	44+48,5 x 35+39,5	QS108C
□ 33 x 42 - (7 x 9)	31+35 x 39,5+44	QS79C	□ 46 x 42 - (10 x 9)	44+48,5 x 39,5+44	QS109C
□ 38 x 33 - (8 x 7)	35+39,5 x 31+35	QS87C	□ 46 x 46 - (10 x 10)	44+48,5 x 44+48,5	QS1010C
□ 38 x 38 - (8 x 8)	35+39,5 x 35+39,5	QS88C	□ 46 x 51 - (10 x 11)	44+48,5 x 48,5+52,5	QS1011C
□ 38 x 42 - (8 x 9)	35+39,5 x 39,5+44	QS89C	□ 46 x 56 - (10 x 12)	44+48,5 x 52,5+57	QS1012C
□ 38 x 46 - (8 x 10)	35+39,5 x 44+48,5	QS810C	□ 51 x 42 - (11 x 9)	48,5+52,5 x 39,5+44	QS119C
□ 42 x 38 - (9 x 8)	39,5+44 x 35+39,5	QS98C	□ 51 x 46 - (11 x 10)	48,5+52,5 x 44+48,5	QS1110C
□ 42 x 42 - (9 x 9)	39,5+44 x 39,5+44	QS99C	□ 51 x 51 - (11 x 11)	48,5+52,5 x 48,5+52,5	QS1111C



O ROHO® QUADTRO SELECT® Low Profile® altezza 5 cm **630,00**

Misure cuscino LxP	Adatto a seduta LSxPS	Codice	Misure cuscino LxP	Adatto a seduta LSxPS	Codice
□ 28 x 30 - (5 x 6)	22+26,5 x 26,5+31	QS56LPC	□ 42 x 42 - (9 x 9)	39,5+44 x 39,5+44	QS99LPC
□ 30 x 30 - (6 x 6)	26,5+31 x 26,5+31	QS66LPC	□ 42 x 46 - (9 x 10)	39,5+44 x 44+48,5	QS910LPC
□ 30 x 33 - (6 x 7)	26,5+31 x 31+35	QS67LPC	□ 42 x 51 - (9 x 11)	39,5+44 x 48,5+52,5	QS911LPC
□ 33 x 33 - (7 x 7)	31+35 x 31+35	QS77LPC	□ 46 x 38 - (10 x 8)	44+48,5 x 35+39,5	QS108LPC
□ 33 x 38 - (7 x 8)	31+35 x 35+39,5	QS78LPC	□ 46 x 42 - (10 x 9)	44+48,5 x 39,5+44	QS109LPC
□ 33 x 42 - (7 x 9)	31+35 x 39,5+44	QS79LPC	□ 46 x 46 - (10 x 10)	44+48,5 x 44+48,5	QS1010LPC
□ 38 x 33 - (8 x 7)	35+39,5 x 31+35	QS87LPC	□ 46 x 51 - (10 x 11)	44+48,5 x 48,5+52,5	QS1011LPC
□ 38 x 38 - (8 x 8)	35+39,5 x 35+39,5	QS88LPC	□ 51 x 42 - (11 x 9)	48,5+52,5 x 39,5+44	QS119LPC
□ 38 x 42 - (8 x 9)	35+39,5 x 39,5+44	QS89LPC	□ 51 x 46 - (11 x 10)	48,5+52,5 x 44+48,5	QS1110LPC
□ 38 x 46 - (8 x 10)	35+39,5 x 44+48,5	QS810LPC	□ 51 x 51 - (11 x 11)	48,5+52,5 x 48,5+52,5	QS1111LPC
□ 42 x 38 - (9 x 8)	39,5+44 x 35+39,5	QS98LPC			



O ROHO® CONTOUR SELECT® **630,00**

Misure cuscino LxP	Adatto a seduta LSxPS	Codice	Misure cuscino LxP	Adatto a seduta LSxPS	Codice
□ 33 x 38 - (7 x 8)	31+35 x 35+39,5	CS78C	□ 42 x 51 - (9 x 11)	39,5+44 x 48,5+52,5	CS911C
□ 38 x 38 - (8 x 8)	35+39,5 x 35+39,5	CS88C	□ 46 x 42 - (10 x 9)	44+48,5 x 39,5+44	CS109C
□ 38 x 42 - (8 x 9)	35+39,5 x 39,5+44	CS89C	□ 46 x 46 - (10 x 10)	44+48,5 x 44+48,5	CS1010C
□ 38 x 46 - (8 x 10)	35+39,5 x 44+48,5	CS810C	□ 46 x 51 - (10 x 11)	44+48,5 x 48,5+52,5	CS1011C
□ 42 x 38 - (9 x 8)	39,5+44 x 35+39,5	CS98C	□ 51 x 42 - (11 x 9)	48,5+52,5 x 39,5+44	CS119C
□ 42 x 42 - (9 x 9)	39,5+44 x 39,5+44	CS99C	□ 51 x 46 - (11 x 10)	48,5+52,5 x 44+48,5	CS1110C
□ 42 x 46 - (9 x 10)	39,5+44 x 44+48,5	CS910C	□ 51 x 51 - (11 x 11)	48,5+52,5 x 48,5+52,5	CS1111C



O ROHO® ENHANCER® **630,00**

Misure cuscino LxP	Adatto a seduta LSxPS	Codice	Misure cuscino LxP	Adatto a seduta LSxPS	Codice
□ 38 x 38 - (8 x 8)	35+39,5 x 35+39,5	ENH88C	□ 46 x 42 - (10 x 9)	44+48,5 x 39,5+44	ENH109C
□ 38 x 42 - (8 x 9)	35+39,5 x 39,5+44	ENH89C	□ 46 x 46 - (10 x 10)	44+48,5 x 44+48,5	ENH1010C
□ 42 x 38 - (9 x 8)	39,5+44 x 35+39,5	ENH98C	□ 46 x 51 - (10 x 11)	44+48,5 x 48,5+52,5	ENH1011C
□ 42 x 42 - (9 x 9)	39,5+44 x 39,5+44	ENH99C	□ 51 x 46 - (11 x 10)	48,5+52,5 x 44+48,5	ENH1110C
□ 42 x 46 - (9 x 10)	39,5+44 x 44+48,5	ENH910C			



Carrozina : Progeo DUKE - Rev. 2023.1	Prezzo IVA esclusa da sommare al prezzo di listino	Pagina da inviare se sono stati scelti optional <input checked="" type="checkbox"/> standard (fornito in assenza di altre indicazioni) <input type="checkbox"/> su richiesta (senza aggiunta di prezzo) <input type="checkbox"/> optional (sommare il prezzo a quello di listino)
---------------------------------------	---	--

Rehaleam s.r.l. - Vicolo Negrelli, 5 - 31038 Castagnole di Paese (TV) - Tel. +39 0422 484657/+39 0422 480367 - Fax +39 0422 484661/+39 0422 484684 - P.IVA IT 03182520266 - C.C.I.A.A. TV n.225867 - iscr.Trib. TV n.41690 Capitale Sociale I.V. Euro 100.000,00
 la società è soggetta ex art. 2497-bis C.C. al coordinamento e direzione della società "PERMOBIL ITALY SRL" iscritta al Registro Imprese Milano Monza Brianza Lodi 10246110968

Email: info_it@permobil.com - web: http://www.rehaleamprogeo.com

Rehateam s.r.l. - Vicoletto Negrelli, 5 - 31038 Castagnole di Paese (TV) - Tel. +39.0422.484657/+39.0422.480387 - Fax +39.0422.484661/+39.0422.484684 - P.IVA IT 03182520266 - C.C.I.A.A. TV n.41690 Capitale Sociale I.V. Euro 100.000,00
 la società è soggetta ex art. 2497-bis C.C. al coordinamento e direzione della società "PERMOBIL ITALY SRL" iscritta al Registro Imprese - Milano Monza Brianza Lodi 10246110968

Data	Commessa	Utilizzatore	Indirizzo
------	----------	--------------	-----------

Ruota 12" - Motore 250W (potenza massima 750W)
 Ruota 14" - Motore 1000W (potenza massima 1500W)
 Display a colori con pulsantiera
 Limite di velocità massima impostabile da display
 5 livelli di velocità selezionabili
 10 livelli di accelerazione selezionabili da display
 Cruise control adattivo (mantiene velocità anche in discesa)
 Leva di comando freno a disco ed elettronico
 Freno motore (regolabile in 10 livelli da display)
 Freno elettronico a pulsante (regolabile in 10 livelli da display)
 Recupero energia in frenata

Gestione messaggi di errore da display (con registro storico)
 Segnalatore acustico retromarcia
 Batteria 48V - 5,8Ah Autonomia fino a 25km
 Batteria potenziata 48V - 11,6Ah Autonomia fino a 50km
 Caricabatteria 48V

Retromarcia
 Ingresso USB
 Cavalletto di stazionamento
 Parafango ruota
 Cupolino anteriore con predisposizione faro FULL LED

(Software certificato)

○ Mototronic

Codici di riconducibilità Nomenclatore Tariffario
 Riconducibile N.T. Cod. 12.21.27.006 - Carrozzina elettrica ad uso interno/esterno
 oppure
 Riconducibile N.T. Cod. 12.24.09.015 - Kit di motorizzazione universale per carrozzine



10979 **3.800,00**

Manubrio

☆ Comandi STANDARD

☆ Acceleratore a pollice e Leva di comando freno a disco ed elettronico (Destra)

○ Acceleratore a manopola e Leva di comando freno a disco ed elettronico

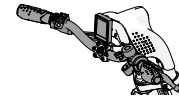

○ Destra
○ Sinistra

10913 **40,00**
10914 **40,00**

○ Comandi per TETRAPLEGICI
Manubrio PUSH&PULL

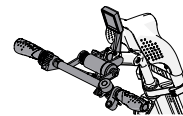

10905 **490,00**

☆ **MOTOTRONIK Ruota 12"**

Motore 250W (potenza massima 750W)
 Velocità massima secondo norma di legge

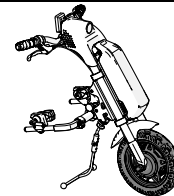

○ **MOTOTRONIK Ruota 14"**

Motore 1000W (potenza massima 1500W)
 Velocità massima secondo norma di legge

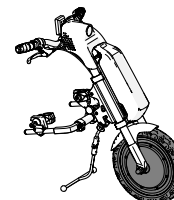

10903 **440,00**

Batteria





☆ Batteria 48V - 5,8Ah *Autonomia fino a 25 km*

○ Batteria potenziata 48V - 11,6Ah *Autonomia fino a 50 km*

10904 **330,00**

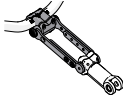
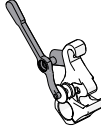
Rehateam s.r.l. Vicolo Negrelli, 5 - 31038 Castagnole di Paese (TV) - Tel. +39.0422.484657/+39.0422.480387 - Fax +39.0422.484657/+39.0422.484684 - P.IVA IT 03182520266 - C.C.I.A.A. TV n.225867 - Iscr. Trib. TV n.41690 Capitale Sociale I.V. Euro 100.000,00
 la società è soggetta ex art. 2497-bis C.C. al coordinamento e direzione della società "PERMOBIL ITALY SRL" iscritta al Registro Imprese Milano Monza Brianza Lodi 10246110968

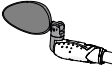
Data	Commessa	Utilizzatore	Indirizzo
------------	----------------	--------------------	-----------------

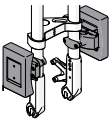
Accessori			
<input type="radio"/> Prolunga manubrio (avvicinamento guida) Regolabile da 15cm fino a 23cm		10907	190,00
<input type="radio"/> Leva sgancio facilitato gruppo motore Consigliato con manubrio per tetraplegici		10915	80,00
<input type="radio"/> FLY Batteria aggiuntiva 48V - 2,9Ah Autonomia fino a 15km Omologata per trasporto aereo		10906	600,00
<input type="radio"/> Faro FULL LED (alta intensità) Incorporato sul cupolino		10908	110,00
<input type="radio"/> Specchietto retrovisore	<input type="radio"/> Destro <input type="radio"/> Sinistro	 10909 10909	40,00 40,00
<input type="radio"/> Cestino (removibile) - (con sistema di aggancio KCLICKfix®)		10912	200,00
<input type="radio"/> Zavorra anteriore removibile - (con sistema di aggancio KCLICKfix®) (Aumenta il peso della ruota motrice per migliorare la trazione)		10910	300,00
<input type="radio"/> Sacca da trasporto		10916	150,00

Note

Carrozzina : Progeo DUKE - Rev. 2023.1	Prezzo IVA esclusa <small>da sommare al prezzo di listino</small>	<table border="1" style="width:100%; border-collapse: collapse;"> <thead> <tr> <th colspan="2" style="text-align: left; padding: 2px;">Pagina da inviare se sono stati scelti optional</th> </tr> </thead> <tbody> <tr> <td style="width:10%; text-align: center; padding: 2px;">☆</td> <td style="padding: 2px;">standard (fornito in assenza di altre indicazioni)</td> </tr> <tr> <td style="text-align: center; padding: 2px;">☐</td> <td style="padding: 2px;">su richiesta (senza aggiunta di prezzo)</td> </tr> <tr> <td style="text-align: center; padding: 2px;">○</td> <td style="padding: 2px;">optional (sommare il prezzo a quello di listino)</td> </tr> </tbody> </table>	Pagina da inviare se sono stati scelti optional		☆	standard (fornito in assenza di altre indicazioni)	☐	su richiesta (senza aggiunta di prezzo)	○	optional (sommare il prezzo a quello di listino)
Pagina da inviare se sono stati scelti optional										
☆	standard (fornito in assenza di altre indicazioni)									
☐	su richiesta (senza aggiunta di prezzo)									
○	optional (sommare il prezzo a quello di listino)									

Email: info_it@permobil.com - web: http://www.rehateamprogeo.com

Data Commessa Utilizzatore Indirizzo

SMARTDRIVE



SMARTDRIVE MX2 - 6KM/H
compreso di caricabatteria

- SWITCH CONTROL (DX+SX) - EU MX2-S002 4.000,00
- SWITCH CONTROL + JACK 3.5 - EU MX2-S003 4.000,00
- SPEED CONTROL DIAL - EU MX2-S001 4.250,00

SMARTDRIVE MX2 - 9KM/H
compreso di caricabatteria

- SWITCH CONTROL (DX+SX) - EU MX2-S005 4.100,00
- SWITCH CONTROL + JACK 3.5 - EU MX2-S006 4.100,00
- SPEED CONTROL DIAL - EU MX2-S004 4.350,00

SWITCH CONTROL



SWITCH CONTROL + JACK (3,5 mono)



Ingresso femmina Mono, permette di collegare SmartDrive con un qualsiasi altro dispositivo di comando/guida.

SPEED CONTROL DIAL



Manopola di controllo graduale della velocità

KIT FISSAGGIO TELAIO RIGIDO

Scegliere kit di fissaggio in funzione della misura delle ruote posteriori della carrozzina

- kit fissaggio telaio rigido - ruote posteriori 22" - 24" MX2-44S-C
- kit fissaggio telaio rigido - ruote posteriori 25" MX2-45S-C
- kit fissaggio telaio rigido - ruote posteriori 26" MX2-46S-C

PUSHTRACKER

- ☆ SENZA Push Tracker MX2-NOPT
- Userò il mio Apple Watch (non fornito da Permobil)
Configurazione semplice e veloce
Maggiore visibilità dello schermo
Prestazioni della batteria migliorate
App gratuita su Apple Store
Compatibile con Apple Watch 5 e successivi, IOS8 e successivi.
- PushTracker E3 Basic MX2-33P 250,00
Nessun telefono/Wi-Fi richiesto
App precaricate per una facile configurazione in pochi minuti
Più piccolo, più leggero e più comodo
Migliore durata della batteria
Più reattivo ed efficiente
- PushTracker E3 MX2-33S 250,00
Richiede l'installazione e configurazione completa da parte dell'utente
Connesso con il tuo telefono cellulare ha tutte le funzionalità di uno Smartwatch.



Accessori

- Borsa da trasporto MX2SD-BAG 60,00
- Maniglia universale imbottita
Maniglia universale imbottita MX2-986 20,00



Pagina da inviare se sono stati scelti optional

- ☆ standard (fornito in assenza di altre indicazioni)
- su richiesta (senza aggiunta di prezzo)
- optional (sommare il prezzo a quello di listino)

Carrozzina : Progeo DUKE - Rev. 2023.1

Prezzo IVA esclusa
da sommare al prezzo di listino