

Rehateam s.r.l. - Vicolo Negrelli, 5 - 31038 Castagnole di Paese (TV) - Tel. +39.0422.484657/+39.0422.484657 - Fax +39.0422.484657/+39.0422.484654 - P.IVA IT 03182520266 - C.C.I.A.A. TV n.41690 Capitale Sociale I.V. Euro 100.000,00  
 la società è soggetta ex art. 2497-bis C.C. al coordinamento e direzione della società "PERMOBIL ITALY SRL" iscritta al Registro Imprese Milano Monza Brianza Lodi 10246110968

**Italia**

Data .....

Utilizzatore ..... Timbro ditta

Peso utilizzatore .....

Responsabile .....

**Carrozzina superleggera pieghevole**  
**Versione standard completamente in tariffario**  
**Cod. 12.21.06.060**

**Misure carrozzina**

Larghezza sedile (LS)  36  39  42  45

Profondità sedile (PS)  35  37,5  40  42,5  45  47,5  
**La profondità seduta effettiva misurata da inizio tela sedile a tubo schienale risulta maggiorata di 2 cm**

Distanza pedana (DP) ..... (cm)  
**(Distanza tela sedile - piatto pedana) - ATTENZIONE! Altezza anteriore minimo 4 cm. maggiore della DISTANZA PEDANA**  
**Vedi Tabelle di Riferimento N°3**

Assetto  Standard  Prudente  Attivo

Altezza schienale (TS) Val.Standard 33,5 ..... (min 24.5-max 47)

Schienale con regolazione dell'inclinazione da -4° a +12°

Campanatura  0°  2°

---

ALTEZZA ANTERIORE ..... (STD 49) - ALTEZZA POSTERIORE ..... (STD 43)

**Telaio anteriore**

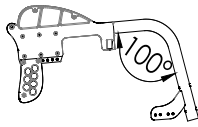
Telaio standard in alluminio Angolo 100° 

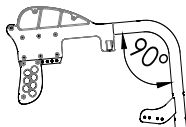
Telaio in alluminio Angolo 90° - (max. ruota anteriore da 5") 

**Colore telaio**

- Argento brillante
- Nero lucido
- Azzurro brillante
- Antracite brillante
- Arancio brillante
- Fucsia brillante
- Rosso brillante
- Lime brillante
- Blu china brillante
- Bianco perlato

**Schienale**

Imbottitura tensionabile traspirante

**Tubi maniglia**

Tubi con maniglia standard

Maniglie ribaltabili 

02958 **220,00**

**Colour set: Ruote posteriori e forcelle anteriori - Abbinabile solo con: Ruote posteriori Superleggera Standard Progeo (22 - 24)**

<input checked="" type="checkbox"/> Nero lucido	22" 24" 25" 26"		
<input type="checkbox"/> Argento brillante	22" 24"	00833	<b>130,00</b>
<input type="checkbox"/> Antracite brillante	24"	00833	<b>130,00</b>
<input type="checkbox"/> Arancio brillante	22" 24"	00833	<b>130,00</b>
<input type="checkbox"/> Fucsia brillante	22" 24"	00833	<b>130,00</b>
<input type="checkbox"/> Azzurro brillante	22" 24"	00833	<b>130,00</b>
<input type="checkbox"/> Rosso brillante	22" 24"	00833	<b>130,00</b>
<input type="checkbox"/> Lime brillante	22" 24"	00833	<b>130,00</b>
<input type="checkbox"/> Bianco perlato	22" 24"	00833	<b>130,00</b>

**Ruote anteriori**

4" Piena Soft

3" Sport

5" Piena Soft

6" Piena Soft (Disponibile solo con telaio angolo 100°)

6" Pneumatica (Disponibile solo con telaio angolo 100°)

3" Active Soft (larga) (Cerchio in lega di alluminio) 06824 **120,00**



4" Active Sport (stretta) (Cerchio in lega di alluminio) 01398 **120,00**

4" Active Soft (larga) (Cerchio in lega di alluminio) 03943 **120,00**

5" Active Soft (larga) (Cerchio in lega di alluminio) 07518 **120,00**

5" Pneumatica 10844 **60,00**

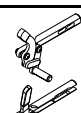
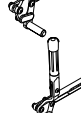
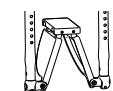
Rehateam s.r.l. Vicolo Negrelli, 5 - 31038 Castagnole di Paese (TV) - Tel. +39.0422.484657/+39.0422.480387 - Fax +39.0422.484661/+39.0422.484684 - P.IVA IT 03182520266 - C.C.I.A.A. TV n.41690 Capitale Sociale I.V. Euro 100.000,00  
 la società è soggetta ex art. 2497-bis C.C. al coordinamento e direzione della società "PERMOBIL ITALY S.R.L." iscritta al Registro Imprese Milano Monza Brianza Lodi 10246110968  
 Email: info\_it@permobil.com - web: http://www.rehateamprogeo.com

Data	Commessa	Utilizzatore	Indirizzo
<b>Ruote posteriori</b>			
<input checked="" type="checkbox"/> 24" Superleggera Standard Progeo <input type="checkbox"/> 22" Superleggera Standard Progeo <input type="checkbox"/> 25" Superleggera Standard Progeo (solo colore nero) <input type="checkbox"/> 26" Superleggera Progeo (solo colore nero) <input type="checkbox"/> 24" ULTRALEGGERA PROGEO KEY SPORT Riduzione del peso circa 450gr. <span style="float: right;">04383 <b>750,00</b></span> <input type="checkbox"/> 24" Superleggera "Spinergy LX" <span style="float: right;">01685 <b>750,00</b></span> <input type="checkbox"/> 24" Superleggera "Spinergy LXL" <input type="checkbox"/> Raggi bianchi e mozzo nero <input type="checkbox"/> Raggi e mozzo neri <span style="float: right;">07846 <b>750,00</b></span> <input type="checkbox"/> 24" Superleggera "Spinergy Flex rim" <b>Corrimano incorporato Alluminio/Gomma</b> <span style="float: right;">02270 <b>1.200,00</b></span> <input type="checkbox"/> 25" Superleggera "Spinergy LX" <span style="float: right;">02101 <b>750,00</b></span> <input type="checkbox"/> 25" Superleggera "Spinergy LXL" <input type="checkbox"/> Raggi bianchi e mozzo nero <span style="float: right;">07847 <b>750,00</b></span> <input type="checkbox"/> 26" Superleggera "Spinergy LX" <span style="float: right;">02102 <b>750,00</b></span> <input type="checkbox"/> 24" Fuoristrada (corrimano in alluminio nero) <span style="float: right;">01392 <b>250,00</b></span>			
<b>Copertura ruota posteriore</b>			
<input checked="" type="checkbox"/> Liscio Alta Pressione (22"-24"-25"-26") <input type="checkbox"/> Tassellato Alta Pressione (24") <input type="checkbox"/> Marathon Plus (24"-25") <b>con protezione anti foratura</b> <span style="float: right;">01669 <b>65,00</b></span> <input type="checkbox"/> Copertura piena - Colore Nero (24") <span style="float: right;">11083 <b>110,00</b></span> <input type="checkbox"/> Copertura piena - Colore Grigio (24") <span style="float: right;">11083 <b>110,00</b></span> <input type="checkbox"/> Copertura piena - Colore Grigio (22") <span style="float: right;">04181 <b>110,00</b></span>			
<b>Cerchi di spinta</b>			
<b>Distanza ruota</b> <input checked="" type="checkbox"/> 3 cm <input type="checkbox"/> 4 cm <input checked="" type="checkbox"/> Alluminio (22"-24"-25"-26") <span style="float: right;">09170 <b>110,00</b></span> <input type="checkbox"/> Alluminio Nero SOFT-TOUCH (24"-25") (Corrimano 24", su ruota da 25" viene installato con distanziali) <span style="float: right;">01684 <b>170,00</b></span> <input type="checkbox"/> Acciaio cromato (24"-25") (Corrimano 24", su ruota da 25" viene installato con distanziali) <span style="float: right;">00016 <b>270,00</b></span> <input type="checkbox"/> Titanio (24"-25") (Corrimano 24", su ruota da 25" viene installato con distanziali) <span style="float: right;">00017 <b>300,00</b></span> <input type="checkbox"/> Ultra Grepp (24"-25") (Corrimano 24", su ruota da 25" viene installato con distanziali) <span style="float: right;">00834 <b>330,00</b></span> <input type="checkbox"/> Max Grepp (24"-25") (Corrimano 24", su ruota da 25" viene installato con distanziali) <span style="float: right;">00632 <b>330,00</b></span> <input type="checkbox"/> Ergo Para (24") <span style="float: right;">11023 <b>290,00</b></span> <input type="checkbox"/> TOP FRICTION (24"-25") (Corrimano 24", su ruota da 25" viene installato con distanziali) <b>Profilo ovale con inserto in gomma</b> <input type="checkbox"/> NOVA H (24"-25") (Corrimano 24", su ruota da 25" viene installato con distanziali) <span style="float: right;">11025 <b>270,00</b></span> <b>Profilo ergonomico colore nero</b> <input type="checkbox"/> NOVA D (24"-25") (Corrimano 24", su ruota da 25" viene installato con distanziali) <span style="float: right;">11026 <b>290,00</b></span> <b>Profilo ergonomico con rivestimento in gomma (ideale per tetraplegici)</b> <input type="checkbox"/> SURGE LT (25") <b>Profilo ovale con inserto in gomma</b> <span style="float: right;">06427 <b>320,00</b></span> <input type="checkbox"/> Timone (24") (24") <span style="float: right;">00693 <b>200,00</b></span> <input type="checkbox"/> Anello anti scivolo in silicone applicabile su cerchio in alluminio Disponibile per misure da (22"- 24" - 26") <span style="float: right;">04050 <b>170,00</b></span>			
<b>Freni</b>			
<input checked="" type="checkbox"/> Freno leva curva da spingere <input type="checkbox"/> Freno leva dritta da spingere <input type="checkbox"/> Freno leva dritta da tirare <input type="checkbox"/> Freno con leva prolungata da spingere <input type="checkbox"/> Freno con leva prolungata da tirare <div style="text-align: right;">  <span style="float: right;">01949 <b>70,00</b></span>   <span style="float: right;">03372 <b>70,00</b></span> </div>			
<b>Pedana - Vedi Tabelle di Riferimento N°3</b>			
<input checked="" type="checkbox"/> Pedana chiudibile autom. a libro regolabile in profondità e inclinazione <input type="checkbox"/> interna <input checked="" type="checkbox"/> 2/3 interna <input type="checkbox"/> esterna <span style="float: right;">11526</span> <b>Distanza pedana minima possibile 32,5cm, calcolate in configurazione standard e con pedane nella posizione interna</b> <input type="checkbox"/> Distanza pedana minima possibile 25cm. Disponibile solo con Sistema multifunzione rotativo - 03945 <b>180,00</b>			
<input type="checkbox"/> Pedana unica alzabile regolabile in profondità e inclinazione <input type="checkbox"/> interna <input checked="" type="checkbox"/> 2/3 interna <input type="checkbox"/> esterna <span style="float: right;">11527</span> <b>Distanza pedana minima possibile 32,5cm, calcolate in configurazione standard e con pedane nella posizione interna</b> <input type="checkbox"/> Distanza pedana minima possibile 26cm. Disponibile solo con Sistema multifunzione rotativo - 03945 <b>180,00</b>			
<input type="checkbox"/> Pedana unica alzabile in alluminio regolabile in profondità e inclinazione <input type="checkbox"/> interna <input checked="" type="checkbox"/> 2/3 interna <input type="checkbox"/> 2/3 esterna <input type="checkbox"/> esterna <span style="float: right;">11528</span> <b>Distanza pedana minima possibile 32,5cm, calcolate in configurazione standard e con pedane nella posizione interna</b>			
<input type="checkbox"/> Pedana sdoppiata in plastica regolabile in inclinazione <input checked="" type="checkbox"/> 2/3 interna <input type="checkbox"/> 2/3 esterna <span style="float: right;">11525</span> <b>Distanza pedana minima possibile 34 cm, calcolate in configurazione standard e con pedane nella posizione interna</b> <b>Aumento del peso circa 500gr.</b> <b>Prevede l'installazione del sistema di unione a fascia.</b>			
<input type="checkbox"/> Pedana COMPACT, chiudibile autom. a libro, regolabile in profondità e inclinazione <span style="float: right;">09957 <b>220,00</b></span> <b>Distanza pedana minima possibile 35cm.</b> <input checked="" type="checkbox"/> interna <input type="checkbox"/> esterna <div style="text-align: right;">  </div>			
<input type="checkbox"/> Pedana unica in carbonio alzabile, regolabile in inclinazione e girevole <input checked="" type="checkbox"/> interna <input type="checkbox"/> esterna <span style="float: right;">03291 <b>270,00</b></span> <b>Distanza pedana minima possibile 32,5cm, calcolate in configurazione standard e con pedane nella posizione interna</b> <div style="text-align: right;">  </div>			







Rehateam s.r.l. Vicolo Negrelli, 5 - 31038 Castagnole di Paese (TV) - Tel. +39.0422.484657/+39.0422.480387 - Fax +39.0422.484661/+39.0422.484684 - P.IVA IT 03182520266 - C.C.I.A.A. TV n.225867 - Iscr.Trib. TV n.41690 Capitale Sociale I.V. Euro 100.000,00  
 la società è soggetta ex art. 2497-bis C.C. al coordinamento e direzione della società "PERMOBIL ITALY SRL" iscritta al Registro Imprese Milano Monza Brianza Lodi 10246110968

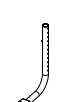

Data .....	Commessa .....	Utilizzatore .....	Indirizzo .....
------------	----------------	--------------------	-----------------

<b>Protezione vestiario</b>			
<input checked="" type="checkbox"/> Parafango in ABS			
<input type="checkbox"/> Protezione dritta			
<input type="checkbox"/> Parafango Carbonio		03946	<b>290,00</b>
<input type="checkbox"/> Sovraprezzo per VERSIONE ESTRAIBILE		03960	<b>110,00</b>

<b>Braccioli</b>			
<input type="checkbox"/> Braccioli Tubolari	(Girevoli estraibili regolabili in altezza)		00694 <b>250,00</b>

<b>Accessori</b>			
<input type="checkbox"/> Imbottitura paracolpi telaio anteriore		07058	<b>50,00</b>
<input type="checkbox"/> Patella di raccordo schienale/tela sedile		10241	<b>20,00</b>
<input type="checkbox"/> Borsello portaoggetti removibile (con aggancio rapido)		09811	<b>120,00</b>

<b>Optional 1</b>			
<input type="checkbox"/> Ruote ascensore			00836 <b>170,00</b>
<input type="checkbox"/> Ruota antiribaltamento con aggancio rapido	(rotazione all'interno per ridurre l'ingombro)		
	<input type="checkbox"/> Destra		00023 <b>130,00</b>
	<input type="checkbox"/> Sinistra		00024 <b>130,00</b>
<input type="checkbox"/> Aiuto ribaltamento	<input type="checkbox"/> Destro		00025 <b>90,00</b>
	<input type="checkbox"/> Sinistro		01046 <b>90,00</b>
<input type="checkbox"/> Porta stampelle	<input type="checkbox"/> Destro		00838 <b>80,00</b>
	<input type="checkbox"/> Sinistro		00837 <b>80,00</b>

<b>Optional 2</b>			
<input type="checkbox"/> Tetraclip	(perno estrazione rapida per tetraplegici)		03947 <b>170,00</b>
<input type="checkbox"/> Cinghia pelvica di ancoraggio			03972 <b>70,00</b>
<input type="checkbox"/> Cinghia di bretellaggio			04103 <b>130,00</b>
<input type="checkbox"/> Maniglie di spinta per accompagnatore	(Regolabili in altezza ed estraibili)		01048 <b>190,00</b>
<input type="checkbox"/> Forcelle estrazione rapida			00030 <b>170,00</b>
<input type="checkbox"/> Supporto lombare	(da inserire all'interno dello schienale)		00013 <b>50,00</b>
<input type="checkbox"/> Spinta laterale	<input type="checkbox"/> Destra		02097 <b>250,00</b>
<b>Non disponibile con Schienale posturale PHYSIO</b>	<input type="checkbox"/> Sinistra		02098 <b>250,00</b>
<input type="checkbox"/> Copriraggi Nero	(22"-24")		01043 <b>160,00</b>
<input type="checkbox"/> Copriraggi Trasparente	(22"-24")		00835 <b>160,00</b>
<input type="checkbox"/> Copriraggi Colorato Progeo Design	(22"-24")		00019 <b>180,00</b>
<input type="checkbox"/> Copriraggi Dragon	(22"-24")		02106 <b>180,00</b>

<b>Kit aggiuntivo</b>			
<input type="checkbox"/> Ruote posteriori 24" Fuoristrada	Copertone Fuoristrada - corrimano in alluminio (colore nero)	03378	<b>500,00</b>
<input type="checkbox"/> Ruote posteriori FAT 24"	Copertone liscio FAT 3" - corrimano in alluminio (colore nero)	09357	<b>850,00</b>

Email: info\_1@permobil.com - web: http://www.rehateamprogeo.com

Data ..... Commessa ..... Utilizzatore ..... Indirizzo .....

**PHYSIO - Schienale posturale - Schienale originale non fornito**

Estraibile con aggancio rapido  
Installazione su tubi diametro 18÷26mm  
Regolazione in profondità (4cm)  
Regolazione inclinazione (±18°)

**AIR** Guscio CARBONIO

ALTEZZA SCHIENALE	28	34	40	
Conformazione del guscio 	Ala di contenimento laterale A=alta - R=regolare			
	A	R	A	R
	<input type="checkbox"/>	<input type="checkbox"/>	<input type="checkbox"/>	<input type="checkbox"/>

840,00

**POSTURE** Guscio ALLUMINIO

ALTEZZA SCHIENALE	34	40	52	
Conformazione del guscio 	Ala di contenimento laterale R=regolare			
	R	R	R	
	<input type="checkbox"/>	<input type="checkbox"/>	<input type="checkbox"/>	

810,00

**Configurazione DEEP con PAD per contenimento laterale (regolabili in altezza)**

Pad in alluminio con imbottitura e rivestimento in tessuto traspirante



Piccolo (h 13cm)



Destro 10272

40,00

Sinistro 10272

Grande (h 20cm)



Destro 10273

50,00

Sinistro 10273

50,00

**Supporti toracici (spinta laterale) - SWING AWAY - Girevole**

Hardware di fissaggio e regolazione completi di imbottitura paracolpi  
Pad in alluminio con imbottitura e rivestimento in tessuto traspirante

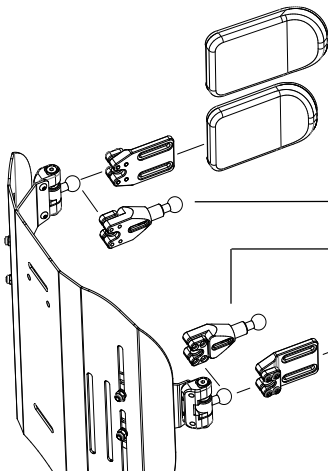

Grande (18x12)

05647 170,00

Piccola (14x9)

05643 170,00

Prolunga supporto toracico

Quantità (n° pz).....

10271 60,00

Prolunga supporto toracico

Quantità (n° pz).....

10271 60,00

Piccola (14x9)

05642 170,00

Grande (18x12)

05646 170,00

Poggiatesta multiregolazione - sistema di montaggio a doppia sfera  
Disponibile solo su schienale Physio  
Non disponibile su schienale Physio AIR Guscio in Carbonio

Grande (34x14)

05648 360,00

Piccolo (28x14)





Rehateam s.r.l. Vicolo Negrelli, 5 - 31038 Castagnole di Paese (TV) - Tel. +39.0422.484657/+39.0422.480387 - Fax +39.0422.484661/+39.0422.484884 - P.IVA IT 03182520266 - C.C.I.A.A. TV n.41690 Capitale Sociale I.V. Euro 100.000,00 la società è soggetta ex art. 2497-bis C.C. al coordinamento e direzione della società "PERMOBIL ITALY SRL" iscritta al Registro Imprese Milano Monza Brianza Lodi: 10246110968

Email: info\_it@permobil.com - web: http://www.rehateamprogeo.com



## TABELLE DI RIFERIMENTO

 Rehateam s.r.l. - Vicolo Negrelli, 5 - 31038 Castagnole di Paese (TV) - Tel. +39.0422.484657/+39.0422.480387 - Fax +39.0422.484661/+39.0422.484684 - P.IVA IT 03182520266 - C.C.I.A.A. TV n.41690 Capitale Sociale I.V. Euro 100.000,00  
 la società è soggetta ex art. 2497-bis C.C. al coordinamento e direzione della società "PERMOBIL ITALY SRL" iscritta al Registro Imprese Milano Monza Brianza Lodi 10246110968

1		ALTEZZA ANTERIORE			
		FORCELLA	Ruote anteriori		
		3"	4"	5"	6"
PICCOLA 	min	43	44	46	
	max	44	45		
MEDIA 	min	46	46	46	46
	max	47	48	49	51
GRANDE 	min	49	49	49	49
	max	50	51	52	53

**Il tipo di forcella montata, verrà definito solo da PROGEO, in base alle caratteristiche e alla conformazione finale della carrozzina.**







2		ALTEZZA POSTERIORE			
		Ruote posteriori			
		22"	24"	25"	26"
H min		min. 40	min. 41	min. 42	min. 43
H max		max 47	max 49	max 50	max 51

3	Tipo Pedana	Distanza pedana	
		Argento	Nero
	Pedana chiudibile autom. a libro	min. 32,5	min. 32,5
	Pedana unica alzabile	min. 32,5	min. 32,5
	Pedana unica alzabile con sistema rotativo multifunzione	min. 27,5	min. 29
	Pedana unica alzabile in alluminio	min. 32,5	min. 32,5
	Pedana sdoppiata in plastica	min. 34	min. 34
	Pedana unica in carbonio	min. 32,5	min. 32,5

**Calcolate in configurazione standard e con pedane nella posizione interna**  
**ATTENZIONE! Altezza anteriore minimo 4 cm. maggiore della DISTANZA PEDANA**

4		Ruote posteriori	
Modello		Caratteristiche	
22" Superleggere Standard Progeo		(non disponibile in colore antracite) - (corrimano in alluminio copertone alta pressione liscio)	
24" Superleggera Standard Progeo		(colori tutti disponibili)	
24" ULTRALEGGERA PROGEO KEY SPORT		(mozzo argento, cerchio e 16 raggi neri)	
24" Superleggere "Spinergy LX"		(mozzo argento, cerchio e 12 raggi neri)	
24" Superleggere "Spinergy LXL"		(mozzo e cerchio neri, 18 raggi bianchi piatti) - (mozzo, cerchio e 18 raggi tondi neri)	
24" Superleggere "Spinergy Flex rim"		(mozzo argento, cerchio e 12 raggi neri) - (corrimano incorporato Alluminio/Gomma riduzione ingombro fino a 3 cm. - tutti i copertoni)	
24" Fuoristrada		(solo colore nero) - (corrimano in alluminio - copertone Fuoristrada)	
25" Superleggere "Spinergy LX"		(mozzo argento, cerchio e 12 raggi neri)	
25" Superleggere "Spinergy LXL"		(mozzo e cerchio neri, 18 raggi bianchi piatti)	
26" Superleggere Progeo		(solo colore nero)	
26" Superleggere "Spinergy LX"		(mozzo argento, cerchio e 18 raggi neri)	

Carrozzina : Progeo YOGA - Rev. 2023.0

Data	Commessa	Utilizzatore	Indirizzo																																																																								
<b>ROHO® MOSAIC® - H7cm - Limite di peso 143Kg</b> <span style="float: right;">200,00</span>																																																																											
<table border="1"> <thead> <tr> <th>Misure cuscino LxP</th> <th>Adatto a seduta LSxPS</th> <th>Codice</th> </tr> </thead> <tbody> <tr><td><input type="checkbox"/> 41 x 41</td><td>42 x 42</td><td>MOS1616HD</td></tr> <tr><td><input type="checkbox"/> 41 x 46</td><td>42 x 47</td><td>MOS1618HD</td></tr> <tr><td><input type="checkbox"/> 44 x 44</td><td>44 x 44</td><td>MOS1717HD</td></tr> </tbody> </table>	Misure cuscino LxP	Adatto a seduta LSxPS	Codice	<input type="checkbox"/> 41 x 41	42 x 42	MOS1616HD	<input type="checkbox"/> 41 x 46	42 x 47	MOS1618HD	<input type="checkbox"/> 44 x 44	44 x 44	MOS1717HD		<table border="1"> <thead> <tr> <th>Misure cuscino LxP</th> <th>Adatto a seduta LSxPS</th> <th>Codice</th> </tr> </thead> <tbody> <tr><td><input type="checkbox"/> 46 x 41</td><td>47 x 42</td><td>MOS1816HD</td></tr> <tr><td><input type="checkbox"/> 46 x 46</td><td>47 x 47</td><td>MOS1818HD</td></tr> <tr><td><input type="checkbox"/> 51 x 46</td><td>52 x 47</td><td>MOS2018HD</td></tr> </tbody> </table>	Misure cuscino LxP	Adatto a seduta LSxPS	Codice	<input type="checkbox"/> 46 x 41	47 x 42	MOS1816HD	<input type="checkbox"/> 46 x 46	47 x 47	MOS1818HD	<input type="checkbox"/> 51 x 46	52 x 47	MOS2018HD																																																	
Misure cuscino LxP	Adatto a seduta LSxPS	Codice																																																																									
<input type="checkbox"/> 41 x 41	42 x 42	MOS1616HD																																																																									
<input type="checkbox"/> 41 x 46	42 x 47	MOS1618HD																																																																									
<input type="checkbox"/> 44 x 44	44 x 44	MOS1717HD																																																																									
Misure cuscino LxP	Adatto a seduta LSxPS	Codice																																																																									
<input type="checkbox"/> 46 x 41	47 x 42	MOS1816HD																																																																									
<input type="checkbox"/> 46 x 46	47 x 47	MOS1818HD																																																																									
<input type="checkbox"/> 51 x 46	52 x 47	MOS2018HD																																																																									
<b>ROHO® AIR LITE® - H9,5cm - Limite di peso 136Kg</b> <span style="float: right;">200,00</span>																																																																											
<table border="1"> <thead> <tr> <th>Misure cuscino LxP</th> <th>Codice</th> </tr> </thead> <tbody> <tr><td><input type="checkbox"/> 33 x 33</td><td>AL1313HD</td></tr> <tr><td><input type="checkbox"/> 33 x 38</td><td>AL1315HD</td></tr> <tr><td><input type="checkbox"/> 36 x 36</td><td>AL1414HD</td></tr> <tr><td><input type="checkbox"/> 36 x 41</td><td>AL1416HD</td></tr> <tr><td><input type="checkbox"/> 38 x 38</td><td>AL1515HD</td></tr> <tr><td><input type="checkbox"/> 38 x 43</td><td>AL1517HD</td></tr> <tr><td><input type="checkbox"/> 41 x 41</td><td>AL1616HD</td></tr> <tr><td><input type="checkbox"/> 41 x 46</td><td>AL1618HD</td></tr> <tr><td><input type="checkbox"/> 43 x 43</td><td>AL1717HD</td></tr> </tbody> </table>	Misure cuscino LxP	Codice	<input type="checkbox"/> 33 x 33	AL1313HD	<input type="checkbox"/> 33 x 38	AL1315HD	<input type="checkbox"/> 36 x 36	AL1414HD	<input type="checkbox"/> 36 x 41	AL1416HD	<input type="checkbox"/> 38 x 38	AL1515HD	<input type="checkbox"/> 38 x 43	AL1517HD	<input type="checkbox"/> 41 x 41	AL1616HD	<input type="checkbox"/> 41 x 46	AL1618HD	<input type="checkbox"/> 43 x 43	AL1717HD		<table border="1"> <thead> <tr> <th>Misure cuscino LxP</th> <th>Codice</th> </tr> </thead> <tbody> <tr><td><input type="checkbox"/> 43 x 46</td><td>AL1718HD</td></tr> <tr><td><input type="checkbox"/> 43 x 51</td><td>AL1720HD</td></tr> <tr><td><input type="checkbox"/> 46 x 41</td><td>AL1816HD</td></tr> <tr><td><input type="checkbox"/> 46 x 46</td><td>AL1818HD</td></tr> <tr><td><input type="checkbox"/> 46 x 51</td><td>AL1820HD</td></tr> <tr><td><input type="checkbox"/> 48 x 43</td><td>AL1917HD</td></tr> <tr><td><input type="checkbox"/> 48 x 48</td><td>AL1919HD</td></tr> <tr><td><input type="checkbox"/> 51 x 43</td><td>AL2017HD</td></tr> <tr><td><input type="checkbox"/> 51 x 46</td><td>AL2018HD</td></tr> </tbody> </table>	Misure cuscino LxP	Codice	<input type="checkbox"/> 43 x 46	AL1718HD	<input type="checkbox"/> 43 x 51	AL1720HD	<input type="checkbox"/> 46 x 41	AL1816HD	<input type="checkbox"/> 46 x 46	AL1818HD	<input type="checkbox"/> 46 x 51	AL1820HD	<input type="checkbox"/> 48 x 43	AL1917HD	<input type="checkbox"/> 48 x 48	AL1919HD	<input type="checkbox"/> 51 x 43	AL2017HD	<input type="checkbox"/> 51 x 46	AL2018HD																																	
Misure cuscino LxP	Codice																																																																										
<input type="checkbox"/> 33 x 33	AL1313HD																																																																										
<input type="checkbox"/> 33 x 38	AL1315HD																																																																										
<input type="checkbox"/> 36 x 36	AL1414HD																																																																										
<input type="checkbox"/> 36 x 41	AL1416HD																																																																										
<input type="checkbox"/> 38 x 38	AL1515HD																																																																										
<input type="checkbox"/> 38 x 43	AL1517HD																																																																										
<input type="checkbox"/> 41 x 41	AL1616HD																																																																										
<input type="checkbox"/> 41 x 46	AL1618HD																																																																										
<input type="checkbox"/> 43 x 43	AL1717HD																																																																										
Misure cuscino LxP	Codice																																																																										
<input type="checkbox"/> 43 x 46	AL1718HD																																																																										
<input type="checkbox"/> 43 x 51	AL1720HD																																																																										
<input type="checkbox"/> 46 x 41	AL1816HD																																																																										
<input type="checkbox"/> 46 x 46	AL1818HD																																																																										
<input type="checkbox"/> 46 x 51	AL1820HD																																																																										
<input type="checkbox"/> 48 x 43	AL1917HD																																																																										
<input type="checkbox"/> 48 x 48	AL1919HD																																																																										
<input type="checkbox"/> 51 x 43	AL2017HD																																																																										
<input type="checkbox"/> 51 x 46	AL2018HD																																																																										
<b>ROHO® HYBRID ELITE SR® - Monovalvola - Sensor Ready - Limite di peso 225Kg</b> <span style="float: right;">630,00</span>																																																																											
<table border="1"> <thead> <tr> <th>Misure cuscino LxP</th> <th>Adatto a seduta LSxPS</th> <th>Codice</th> </tr> </thead> <tbody> <tr><td><input type="checkbox"/> 35 x 37,5</td><td>36 x 36</td><td>1RHE1414C-SR</td></tr> <tr><td><input type="checkbox"/> 35 x 40</td><td>36 x 38</td><td>1RHE1415C-SR</td></tr> <tr><td><input type="checkbox"/> 35 x 43</td><td>36 x 41</td><td>1RHE1416C-SR</td></tr> <tr><td><input type="checkbox"/> 37,5 x 40</td><td>38 x 38</td><td>1RHE1515C-SR</td></tr> <tr><td><input type="checkbox"/> 37,5 x 43</td><td>38 x 41</td><td>1RHE1516C-SR</td></tr> <tr><td><input type="checkbox"/> 37,5 x 45</td><td>38 x 43</td><td>1RHE1517C-SR</td></tr> <tr><td><input type="checkbox"/> 40 x 40</td><td>41 x 38</td><td>1RHE1615C-SR</td></tr> <tr><td><input type="checkbox"/> 40 x 43</td><td>41 x 41</td><td>1RHE1616C-SR</td></tr> <tr><td><input type="checkbox"/> 40 x 45</td><td>41 x 43</td><td>1RHE1617C-SR</td></tr> <tr><td><input type="checkbox"/> 40 x 48</td><td>41 x 46</td><td>1RHE1618C-SR</td></tr> <tr><td><input type="checkbox"/> 40 x 53</td><td>41 x 51</td><td>1RHE1620C-SR</td></tr> </tbody> </table>	Misure cuscino LxP	Adatto a seduta LSxPS	Codice	<input type="checkbox"/> 35 x 37,5	36 x 36	1RHE1414C-SR	<input type="checkbox"/> 35 x 40	36 x 38	1RHE1415C-SR	<input type="checkbox"/> 35 x 43	36 x 41	1RHE1416C-SR	<input type="checkbox"/> 37,5 x 40	38 x 38	1RHE1515C-SR	<input type="checkbox"/> 37,5 x 43	38 x 41	1RHE1516C-SR	<input type="checkbox"/> 37,5 x 45	38 x 43	1RHE1517C-SR	<input type="checkbox"/> 40 x 40	41 x 38	1RHE1615C-SR	<input type="checkbox"/> 40 x 43	41 x 41	1RHE1616C-SR	<input type="checkbox"/> 40 x 45	41 x 43	1RHE1617C-SR	<input type="checkbox"/> 40 x 48	41 x 46	1RHE1618C-SR	<input type="checkbox"/> 40 x 53	41 x 51	1RHE1620C-SR		<table border="1"> <thead> <tr> <th>Misure cuscino LxP</th> <th>Adatto a seduta LSxPS</th> <th>Codice</th> </tr> </thead> <tbody> <tr><td><input type="checkbox"/> 43 x 43</td><td>43 x 41</td><td>1RHE1716C-SR</td></tr> <tr><td><input type="checkbox"/> 43 x 45</td><td>43 x 43</td><td>1RHE1717C-SR</td></tr> <tr><td><input type="checkbox"/> 43 x 48</td><td>43 x 46</td><td>1RHE1718C-SR</td></tr> <tr><td><input type="checkbox"/> 43 x 53</td><td>43 x 51</td><td>1RHE1720C-SR</td></tr> <tr><td><input type="checkbox"/> 45 x 43</td><td>46 x 41</td><td>1RHE1816C-SR</td></tr> <tr><td><input type="checkbox"/> 45 x 45</td><td>46 x 43</td><td>1RHE1817C-SR</td></tr> <tr><td><input type="checkbox"/> 45 x 48</td><td>46 x 46</td><td>1RHE1818C-SR</td></tr> <tr><td><input type="checkbox"/> 45 x 53</td><td>46 x 51</td><td>1RHE1820C-SR</td></tr> <tr><td><input type="checkbox"/> 50 x 45</td><td>51 x 43</td><td>1RHE2017C-SR</td></tr> <tr><td><input type="checkbox"/> 50 x 48</td><td>51 x 46</td><td>1RHE2018C-SR</td></tr> <tr><td><input type="checkbox"/> 50 x 53</td><td>51 x 51</td><td>1RHE2020C-SR</td></tr> </tbody> </table>	Misure cuscino LxP	Adatto a seduta LSxPS	Codice	<input type="checkbox"/> 43 x 43	43 x 41	1RHE1716C-SR	<input type="checkbox"/> 43 x 45	43 x 43	1RHE1717C-SR	<input type="checkbox"/> 43 x 48	43 x 46	1RHE1718C-SR	<input type="checkbox"/> 43 x 53	43 x 51	1RHE1720C-SR	<input type="checkbox"/> 45 x 43	46 x 41	1RHE1816C-SR	<input type="checkbox"/> 45 x 45	46 x 43	1RHE1817C-SR	<input type="checkbox"/> 45 x 48	46 x 46	1RHE1818C-SR	<input type="checkbox"/> 45 x 53	46 x 51	1RHE1820C-SR	<input type="checkbox"/> 50 x 45	51 x 43	1RHE2017C-SR	<input type="checkbox"/> 50 x 48	51 x 46	1RHE2018C-SR	<input type="checkbox"/> 50 x 53	51 x 51	1RHE2020C-SR	
Misure cuscino LxP	Adatto a seduta LSxPS	Codice																																																																									
<input type="checkbox"/> 35 x 37,5	36 x 36	1RHE1414C-SR																																																																									
<input type="checkbox"/> 35 x 40	36 x 38	1RHE1415C-SR																																																																									
<input type="checkbox"/> 35 x 43	36 x 41	1RHE1416C-SR																																																																									
<input type="checkbox"/> 37,5 x 40	38 x 38	1RHE1515C-SR																																																																									
<input type="checkbox"/> 37,5 x 43	38 x 41	1RHE1516C-SR																																																																									
<input type="checkbox"/> 37,5 x 45	38 x 43	1RHE1517C-SR																																																																									
<input type="checkbox"/> 40 x 40	41 x 38	1RHE1615C-SR																																																																									
<input type="checkbox"/> 40 x 43	41 x 41	1RHE1616C-SR																																																																									
<input type="checkbox"/> 40 x 45	41 x 43	1RHE1617C-SR																																																																									
<input type="checkbox"/> 40 x 48	41 x 46	1RHE1618C-SR																																																																									
<input type="checkbox"/> 40 x 53	41 x 51	1RHE1620C-SR																																																																									
Misure cuscino LxP	Adatto a seduta LSxPS	Codice																																																																									
<input type="checkbox"/> 43 x 43	43 x 41	1RHE1716C-SR																																																																									
<input type="checkbox"/> 43 x 45	43 x 43	1RHE1717C-SR																																																																									
<input type="checkbox"/> 43 x 48	43 x 46	1RHE1718C-SR																																																																									
<input type="checkbox"/> 43 x 53	43 x 51	1RHE1720C-SR																																																																									
<input type="checkbox"/> 45 x 43	46 x 41	1RHE1816C-SR																																																																									
<input type="checkbox"/> 45 x 45	46 x 43	1RHE1817C-SR																																																																									
<input type="checkbox"/> 45 x 48	46 x 46	1RHE1818C-SR																																																																									
<input type="checkbox"/> 45 x 53	46 x 51	1RHE1820C-SR																																																																									
<input type="checkbox"/> 50 x 45	51 x 43	1RHE2017C-SR																																																																									
<input type="checkbox"/> 50 x 48	51 x 46	1RHE2018C-SR																																																																									
<input type="checkbox"/> 50 x 53	51 x 51	1RHE2020C-SR																																																																									
<b>ROHO® HYBRID ELITE® - Bivalvola /Bicompartimento - Limite di peso 225Kg</b> <span style="float: right;">630,00</span>																																																																											
<table border="1"> <thead> <tr> <th>Misure cuscino LxP</th> <th>Adatto a seduta LSxPS</th> <th>Codice</th> </tr> </thead> <tbody> <tr><td><input type="checkbox"/> 35 x 37,5</td><td>36 x 36</td><td>2RHE1414C</td></tr> <tr><td><input type="checkbox"/> 35 x 40</td><td>36 x 38</td><td>2RHE1415C</td></tr> <tr><td><input type="checkbox"/> 35 x 43</td><td>36 x 41</td><td>2RHE1416C</td></tr> <tr><td><input type="checkbox"/> 37,5 x 40</td><td>38 x 38</td><td>2RHE1515C</td></tr> <tr><td><input type="checkbox"/> 37,5 x 43</td><td>38 x 41</td><td>2RHE1516C</td></tr> <tr><td><input type="checkbox"/> 37,5 x 45</td><td>38 x 43</td><td>2RHE1517C</td></tr> <tr><td><input type="checkbox"/> 40 x 40</td><td>41 x 38</td><td>2RHE1615C</td></tr> <tr><td><input type="checkbox"/> 40 x 43</td><td>41 x 41</td><td>2RHE1616C</td></tr> <tr><td><input type="checkbox"/> 40 x 45</td><td>41 x 43</td><td>2RHE1617C</td></tr> <tr><td><input type="checkbox"/> 40 x 48</td><td>41 x 46</td><td>2RHE1618C</td></tr> <tr><td><input type="checkbox"/> 40 x 53</td><td>41 x 51</td><td>2RHE1620C</td></tr> </tbody> </table>	Misure cuscino LxP	Adatto a seduta LSxPS	Codice	<input type="checkbox"/> 35 x 37,5	36 x 36	2RHE1414C	<input type="checkbox"/> 35 x 40	36 x 38	2RHE1415C	<input type="checkbox"/> 35 x 43	36 x 41	2RHE1416C	<input type="checkbox"/> 37,5 x 40	38 x 38	2RHE1515C	<input type="checkbox"/> 37,5 x 43	38 x 41	2RHE1516C	<input type="checkbox"/> 37,5 x 45	38 x 43	2RHE1517C	<input type="checkbox"/> 40 x 40	41 x 38	2RHE1615C	<input type="checkbox"/> 40 x 43	41 x 41	2RHE1616C	<input type="checkbox"/> 40 x 45	41 x 43	2RHE1617C	<input type="checkbox"/> 40 x 48	41 x 46	2RHE1618C	<input type="checkbox"/> 40 x 53	41 x 51	2RHE1620C		<table border="1"> <thead> <tr> <th>Misure cuscino LxP</th> <th>Adatto a seduta LSxPS</th> <th>Codice</th> </tr> </thead> <tbody> <tr><td><input type="checkbox"/> 43 x 43</td><td>43 x 41</td><td>2RHE1716C</td></tr> <tr><td><input type="checkbox"/> 43 x 45</td><td>43 x 43</td><td>2RHE1717C</td></tr> <tr><td><input type="checkbox"/> 43 x 48</td><td>43 x 46</td><td>2RHE1718C</td></tr> <tr><td><input type="checkbox"/> 43 x 53</td><td>43 x 51</td><td>2RHE1720C</td></tr> <tr><td><input type="checkbox"/> 45 x 43</td><td>46 x 41</td><td>2RHE1816C</td></tr> <tr><td><input type="checkbox"/> 45 x 45</td><td>46 x 43</td><td>2RHE1817C</td></tr> <tr><td><input type="checkbox"/> 45 x 48</td><td>46 x 46</td><td>2RHE1818C</td></tr> <tr><td><input type="checkbox"/> 45 x 53</td><td>46 x 51</td><td>2RHE1820C</td></tr> <tr><td><input type="checkbox"/> 50 x 45</td><td>51 x 43</td><td>2RHE2017C</td></tr> <tr><td><input type="checkbox"/> 50 x 48</td><td>51 x 46</td><td>2RHE2018C</td></tr> <tr><td><input type="checkbox"/> 50 x 53</td><td>51 x 51</td><td>2RHE2020C</td></tr> </tbody> </table>	Misure cuscino LxP	Adatto a seduta LSxPS	Codice	<input type="checkbox"/> 43 x 43	43 x 41	2RHE1716C	<input type="checkbox"/> 43 x 45	43 x 43	2RHE1717C	<input type="checkbox"/> 43 x 48	43 x 46	2RHE1718C	<input type="checkbox"/> 43 x 53	43 x 51	2RHE1720C	<input type="checkbox"/> 45 x 43	46 x 41	2RHE1816C	<input type="checkbox"/> 45 x 45	46 x 43	2RHE1817C	<input type="checkbox"/> 45 x 48	46 x 46	2RHE1818C	<input type="checkbox"/> 45 x 53	46 x 51	2RHE1820C	<input type="checkbox"/> 50 x 45	51 x 43	2RHE2017C	<input type="checkbox"/> 50 x 48	51 x 46	2RHE2018C	<input type="checkbox"/> 50 x 53	51 x 51	2RHE2020C	
Misure cuscino LxP	Adatto a seduta LSxPS	Codice																																																																									
<input type="checkbox"/> 35 x 37,5	36 x 36	2RHE1414C																																																																									
<input type="checkbox"/> 35 x 40	36 x 38	2RHE1415C																																																																									
<input type="checkbox"/> 35 x 43	36 x 41	2RHE1416C																																																																									
<input type="checkbox"/> 37,5 x 40	38 x 38	2RHE1515C																																																																									
<input type="checkbox"/> 37,5 x 43	38 x 41	2RHE1516C																																																																									
<input type="checkbox"/> 37,5 x 45	38 x 43	2RHE1517C																																																																									
<input type="checkbox"/> 40 x 40	41 x 38	2RHE1615C																																																																									
<input type="checkbox"/> 40 x 43	41 x 41	2RHE1616C																																																																									
<input type="checkbox"/> 40 x 45	41 x 43	2RHE1617C																																																																									
<input type="checkbox"/> 40 x 48	41 x 46	2RHE1618C																																																																									
<input type="checkbox"/> 40 x 53	41 x 51	2RHE1620C																																																																									
Misure cuscino LxP	Adatto a seduta LSxPS	Codice																																																																									
<input type="checkbox"/> 43 x 43	43 x 41	2RHE1716C																																																																									
<input type="checkbox"/> 43 x 45	43 x 43	2RHE1717C																																																																									
<input type="checkbox"/> 43 x 48	43 x 46	2RHE1718C																																																																									
<input type="checkbox"/> 43 x 53	43 x 51	2RHE1720C																																																																									
<input type="checkbox"/> 45 x 43	46 x 41	2RHE1816C																																																																									
<input type="checkbox"/> 45 x 45	46 x 43	2RHE1817C																																																																									
<input type="checkbox"/> 45 x 48	46 x 46	2RHE1818C																																																																									
<input type="checkbox"/> 45 x 53	46 x 51	2RHE1820C																																																																									
<input type="checkbox"/> 50 x 45	51 x 43	2RHE2017C																																																																									
<input type="checkbox"/> 50 x 48	51 x 46	2RHE2018C																																																																									
<input type="checkbox"/> 50 x 53	51 x 51	2RHE2020C																																																																									
<b>ROHO® HYBRID SELECT®</b> <span style="float: right;">630,00</span>																																																																											
<table border="1"> <thead> <tr> <th>Misure cuscino LxP</th> <th>Adatto a seduta LSxPS</th> <th>Codice</th> </tr> </thead> <tbody> <tr><td><input type="checkbox"/> 35,5 x 37,5</td><td>36x38</td><td>HS1414C</td></tr> <tr><td><input type="checkbox"/> 35,5 x 42,5</td><td>36x43</td><td>HS1416C</td></tr> <tr><td><input type="checkbox"/> 38 x 40</td><td>38x40</td><td>HS1515C</td></tr> <tr><td><input type="checkbox"/> 38 x 42,5</td><td>38x43</td><td>HS1516C</td></tr> <tr><td><input type="checkbox"/> 38 x 45</td><td>38x45</td><td>HS1517C</td></tr> <tr><td><input type="checkbox"/> 40,5 x 40</td><td>41x40</td><td>HS1615C</td></tr> <tr><td><input type="checkbox"/> 40,5 x 42,5</td><td>41x43</td><td>HS1616C</td></tr> <tr><td><input type="checkbox"/> 40,5 x 45</td><td>41x45</td><td>HS1617C</td></tr> <tr><td><input type="checkbox"/> 40,5 x 47,5</td><td>41x48</td><td>HS1618C</td></tr> <tr><td><input type="checkbox"/> 40,5 x 52,5</td><td>41x53</td><td>HS1620C</td></tr> <tr><td><input type="checkbox"/> 43 x 42,5</td><td>43x43</td><td>HS1716C</td></tr> </tbody> </table>	Misure cuscino LxP	Adatto a seduta LSxPS	Codice	<input type="checkbox"/> 35,5 x 37,5	36x38	HS1414C	<input type="checkbox"/> 35,5 x 42,5	36x43	HS1416C	<input type="checkbox"/> 38 x 40	38x40	HS1515C	<input type="checkbox"/> 38 x 42,5	38x43	HS1516C	<input type="checkbox"/> 38 x 45	38x45	HS1517C	<input type="checkbox"/> 40,5 x 40	41x40	HS1615C	<input type="checkbox"/> 40,5 x 42,5	41x43	HS1616C	<input type="checkbox"/> 40,5 x 45	41x45	HS1617C	<input type="checkbox"/> 40,5 x 47,5	41x48	HS1618C	<input type="checkbox"/> 40,5 x 52,5	41x53	HS1620C	<input type="checkbox"/> 43 x 42,5	43x43	HS1716C		<table border="1"> <thead> <tr> <th>Misure cuscino LxP</th> <th>Adatto a seduta LSxPS</th> <th>Codice</th> </tr> </thead> <tbody> <tr><td><input type="checkbox"/> 43 x 45</td><td>43x45</td><td>HS1717C</td></tr> <tr><td><input type="checkbox"/> 43 x 47,5</td><td>43x48</td><td>HS1718C</td></tr> <tr><td><input type="checkbox"/> 43 x 52,5</td><td>43x53</td><td>HS1720C</td></tr> <tr><td><input type="checkbox"/> 45,5 x 42,5</td><td>46x43</td><td>HS1816C</td></tr> <tr><td><input type="checkbox"/> 45,5 x 45</td><td>46x45</td><td>HS1817C</td></tr> <tr><td><input type="checkbox"/> 45,5 x 47,5</td><td>46x48</td><td>HS1818C</td></tr> <tr><td><input type="checkbox"/> 45,5 x 52,5</td><td>46x53</td><td>HS1820C</td></tr> <tr><td><input type="checkbox"/> 51 x 42,5</td><td>51x43</td><td>HS2016C</td></tr> <tr><td><input type="checkbox"/> 51 x 45</td><td>51x45</td><td>HS2017C</td></tr> <tr><td><input type="checkbox"/> 51 x 47,5</td><td>51x48</td><td>HS2018C</td></tr> <tr><td><input type="checkbox"/> 51 x 52,5</td><td>51x53</td><td>HS2020C</td></tr> </tbody> </table>	Misure cuscino LxP	Adatto a seduta LSxPS	Codice	<input type="checkbox"/> 43 x 45	43x45	HS1717C	<input type="checkbox"/> 43 x 47,5	43x48	HS1718C	<input type="checkbox"/> 43 x 52,5	43x53	HS1720C	<input type="checkbox"/> 45,5 x 42,5	46x43	HS1816C	<input type="checkbox"/> 45,5 x 45	46x45	HS1817C	<input type="checkbox"/> 45,5 x 47,5	46x48	HS1818C	<input type="checkbox"/> 45,5 x 52,5	46x53	HS1820C	<input type="checkbox"/> 51 x 42,5	51x43	HS2016C	<input type="checkbox"/> 51 x 45	51x45	HS2017C	<input type="checkbox"/> 51 x 47,5	51x48	HS2018C	<input type="checkbox"/> 51 x 52,5	51x53	HS2020C	
Misure cuscino LxP	Adatto a seduta LSxPS	Codice																																																																									
<input type="checkbox"/> 35,5 x 37,5	36x38	HS1414C																																																																									
<input type="checkbox"/> 35,5 x 42,5	36x43	HS1416C																																																																									
<input type="checkbox"/> 38 x 40	38x40	HS1515C																																																																									
<input type="checkbox"/> 38 x 42,5	38x43	HS1516C																																																																									
<input type="checkbox"/> 38 x 45	38x45	HS1517C																																																																									
<input type="checkbox"/> 40,5 x 40	41x40	HS1615C																																																																									
<input type="checkbox"/> 40,5 x 42,5	41x43	HS1616C																																																																									
<input type="checkbox"/> 40,5 x 45	41x45	HS1617C																																																																									
<input type="checkbox"/> 40,5 x 47,5	41x48	HS1618C																																																																									
<input type="checkbox"/> 40,5 x 52,5	41x53	HS1620C																																																																									
<input type="checkbox"/> 43 x 42,5	43x43	HS1716C																																																																									
Misure cuscino LxP	Adatto a seduta LSxPS	Codice																																																																									
<input type="checkbox"/> 43 x 45	43x45	HS1717C																																																																									
<input type="checkbox"/> 43 x 47,5	43x48	HS1718C																																																																									
<input type="checkbox"/> 43 x 52,5	43x53	HS1720C																																																																									
<input type="checkbox"/> 45,5 x 42,5	46x43	HS1816C																																																																									
<input type="checkbox"/> 45,5 x 45	46x45	HS1817C																																																																									
<input type="checkbox"/> 45,5 x 47,5	46x48	HS1818C																																																																									
<input type="checkbox"/> 45,5 x 52,5	46x53	HS1820C																																																																									
<input type="checkbox"/> 51 x 42,5	51x43	HS2016C																																																																									
<input type="checkbox"/> 51 x 45	51x45	HS2017C																																																																									
<input type="checkbox"/> 51 x 47,5	51x48	HS2018C																																																																									
<input type="checkbox"/> 51 x 52,5	51x53	HS2020C																																																																									
<b>ROHO® MONOCOMPARTIMENT® High Profile® altezza 10 cm</b> <span style="float: right;">335,00</span>																																																																											
<table border="1"> <thead> <tr> <th>Misure cuscino LxP</th> <th>Adatto a seduta LSxPS</th> <th>Codice</th> </tr> </thead> <tbody> <tr><td><input type="checkbox"/> 30 x 30 - (6 x 6)</td><td>26,5+31 x 26,5+31</td><td>1R66C</td></tr> <tr><td><input type="checkbox"/> 30 x 33 - (6 x 7)</td><td>26,5+31 x 31+35</td><td>1R67C</td></tr> <tr><td><input type="checkbox"/> 33 x 33 - (7 x 7)</td><td>31+35 x 31+35</td><td>1R77C</td></tr> <tr><td><input type="checkbox"/> 33 x 38 - (7 x 8)</td><td>31+35 x 35+39,5</td><td>1R78C</td></tr> <tr><td><input type="checkbox"/> 33 x 42 - (7 x 9)</td><td>31+35 x 39,5+44</td><td>1R79C</td></tr> <tr><td><input type="checkbox"/> 38 x 33 - (8 x 7)</td><td>35+39,5 x 31+35</td><td>1R87C</td></tr> <tr><td><input type="checkbox"/> 38 x 38 - (8 x 8)</td><td>35+39,5 x 35+39,5</td><td>1R88C</td></tr> <tr><td><input type="checkbox"/> 38 x 42 - (8 x 9)</td><td>35+39,5 x 39,5+44</td><td>1R89C</td></tr> <tr><td><input type="checkbox"/> 38 x 46 - (8 x 10)</td><td>35+39,5 x 44+48,5</td><td>1R810C</td></tr> <tr><td><input type="checkbox"/> 42 x 38 - (9 x 8)</td><td>39,5+44 x 35+39,5</td><td>1R98C</td></tr> <tr><td><input type="checkbox"/> 42 x 42 - (9 x 9)</td><td>39,5+44 x 39,5+44</td><td>1R99C</td></tr> </tbody> </table>	Misure cuscino LxP	Adatto a seduta LSxPS	Codice	<input type="checkbox"/> 30 x 30 - (6 x 6)	26,5+31 x 26,5+31	1R66C	<input type="checkbox"/> 30 x 33 - (6 x 7)	26,5+31 x 31+35	1R67C	<input type="checkbox"/> 33 x 33 - (7 x 7)	31+35 x 31+35	1R77C	<input type="checkbox"/> 33 x 38 - (7 x 8)	31+35 x 35+39,5	1R78C	<input type="checkbox"/> 33 x 42 - (7 x 9)	31+35 x 39,5+44	1R79C	<input type="checkbox"/> 38 x 33 - (8 x 7)	35+39,5 x 31+35	1R87C	<input type="checkbox"/> 38 x 38 - (8 x 8)	35+39,5 x 35+39,5	1R88C	<input type="checkbox"/> 38 x 42 - (8 x 9)	35+39,5 x 39,5+44	1R89C	<input type="checkbox"/> 38 x 46 - (8 x 10)	35+39,5 x 44+48,5	1R810C	<input type="checkbox"/> 42 x 38 - (9 x 8)	39,5+44 x 35+39,5	1R98C	<input type="checkbox"/> 42 x 42 - (9 x 9)	39,5+44 x 39,5+44	1R99C		<table border="1"> <thead> <tr> <th>Misure cuscino LxP</th> <th>Adatto a seduta LSxPS</th> <th>Codice</th> </tr> </thead> <tbody> <tr><td><input type="checkbox"/> 42 x 46 - (9 x 10)</td><td>39,5+44 x 44+48,5</td><td>1R910C</td></tr> <tr><td><input type="checkbox"/> 42 x 51 - (9 x 11)</td><td>39,5+44 x 48,5+52,5</td><td>1R911C</td></tr> <tr><td><input type="checkbox"/> 46 x 38 - (10 x 8)</td><td>44+48,5 x 35+39,5</td><td>1R108C</td></tr> <tr><td><input type="checkbox"/> 46 x 42 - (10 x 9)</td><td>44+48,5 x 39,5+44</td><td>1R109C</td></tr> <tr><td><input type="checkbox"/> 46 x 46 - (10 x 10)</td><td>44+48,5 x 44+48,5</td><td>1R1010C</td></tr> <tr><td><input type="checkbox"/> 46 x 51 - (10 x 11)</td><td>44+48,5 x 48,5+52,5</td><td>1R1011C</td></tr> <tr><td><input type="checkbox"/> 46 x 56 - (10 x 12)</td><td>44+48,5 x 52,5+57</td><td>1R1012C</td></tr> <tr><td><input type="checkbox"/> 51 x 42 - (11 x 9)</td><td>48,5+52,5 x 39,5+44</td><td>1R119C</td></tr> <tr><td><input type="checkbox"/> 51 x 46 - (11 x 10)</td><td>48,5+52,5 x 44+48,5</td><td>1R1110C</td></tr> <tr><td><input type="checkbox"/> 51 x 51 - (11 x 11)</td><td>48,5+52,5 x 48,5+52,5</td><td>1R1111C</td></tr> <tr><td><input type="checkbox"/> 51 x 56 - (11 x 12)</td><td>48,5+52,5 x 52,5+57</td><td>1R1112C</td></tr> </tbody> </table>	Misure cuscino LxP	Adatto a seduta LSxPS	Codice	<input type="checkbox"/> 42 x 46 - (9 x 10)	39,5+44 x 44+48,5	1R910C	<input type="checkbox"/> 42 x 51 - (9 x 11)	39,5+44 x 48,5+52,5	1R911C	<input type="checkbox"/> 46 x 38 - (10 x 8)	44+48,5 x 35+39,5	1R108C	<input type="checkbox"/> 46 x 42 - (10 x 9)	44+48,5 x 39,5+44	1R109C	<input type="checkbox"/> 46 x 46 - (10 x 10)	44+48,5 x 44+48,5	1R1010C	<input type="checkbox"/> 46 x 51 - (10 x 11)	44+48,5 x 48,5+52,5	1R1011C	<input type="checkbox"/> 46 x 56 - (10 x 12)	44+48,5 x 52,5+57	1R1012C	<input type="checkbox"/> 51 x 42 - (11 x 9)	48,5+52,5 x 39,5+44	1R119C	<input type="checkbox"/> 51 x 46 - (11 x 10)	48,5+52,5 x 44+48,5	1R1110C	<input type="checkbox"/> 51 x 51 - (11 x 11)	48,5+52,5 x 48,5+52,5	1R1111C	<input type="checkbox"/> 51 x 56 - (11 x 12)	48,5+52,5 x 52,5+57	1R1112C	
Misure cuscino LxP	Adatto a seduta LSxPS	Codice																																																																									
<input type="checkbox"/> 30 x 30 - (6 x 6)	26,5+31 x 26,5+31	1R66C																																																																									
<input type="checkbox"/> 30 x 33 - (6 x 7)	26,5+31 x 31+35	1R67C																																																																									
<input type="checkbox"/> 33 x 33 - (7 x 7)	31+35 x 31+35	1R77C																																																																									
<input type="checkbox"/> 33 x 38 - (7 x 8)	31+35 x 35+39,5	1R78C																																																																									
<input type="checkbox"/> 33 x 42 - (7 x 9)	31+35 x 39,5+44	1R79C																																																																									
<input type="checkbox"/> 38 x 33 - (8 x 7)	35+39,5 x 31+35	1R87C																																																																									
<input type="checkbox"/> 38 x 38 - (8 x 8)	35+39,5 x 35+39,5	1R88C																																																																									
<input type="checkbox"/> 38 x 42 - (8 x 9)	35+39,5 x 39,5+44	1R89C																																																																									
<input type="checkbox"/> 38 x 46 - (8 x 10)	35+39,5 x 44+48,5	1R810C																																																																									
<input type="checkbox"/> 42 x 38 - (9 x 8)	39,5+44 x 35+39,5	1R98C																																																																									
<input type="checkbox"/> 42 x 42 - (9 x 9)	39,5+44 x 39,5+44	1R99C																																																																									
Misure cuscino LxP	Adatto a seduta LSxPS	Codice																																																																									
<input type="checkbox"/> 42 x 46 - (9 x 10)	39,5+44 x 44+48,5	1R910C																																																																									
<input type="checkbox"/> 42 x 51 - (9 x 11)	39,5+44 x 48,5+52,5	1R911C																																																																									
<input type="checkbox"/> 46 x 38 - (10 x 8)	44+48,5 x 35+39,5	1R108C																																																																									
<input type="checkbox"/> 46 x 42 - (10 x 9)	44+48,5 x 39,5+44	1R109C																																																																									
<input type="checkbox"/> 46 x 46 - (10 x 10)	44+48,5 x 44+48,5	1R1010C																																																																									
<input type="checkbox"/> 46 x 51 - (10 x 11)	44+48,5 x 48,5+52,5	1R1011C																																																																									
<input type="checkbox"/> 46 x 56 - (10 x 12)	44+48,5 x 52,5+57	1R1012C																																																																									
<input type="checkbox"/> 51 x 42 - (11 x 9)	48,5+52,5 x 39,5+44	1R119C																																																																									
<input type="checkbox"/> 51 x 46 - (11 x 10)	48,5+52,5 x 44+48,5	1R1110C																																																																									
<input type="checkbox"/> 51 x 51 - (11 x 11)	48,5+52,5 x 48,5+52,5	1R1111C																																																																									
<input type="checkbox"/> 51 x 56 - (11 x 12)	48,5+52,5 x 52,5+57	1R1112C																																																																									

Data	Commessa	Utilizzatore	Indirizzo
------	----------	--------------	-----------

<b>O ROHO® MONOCOMPARTIMENT® Low Profile® altezza 5 cm</b>						<b>335,00</b>
<i>Misure cuscino</i> <b>LxP</b>	<i>Adatto a seduta</i> <b>LSxPS</b>	<b>Codice</b>	<i>Misure cuscino</i> <b>LxP</b>	<i>Adatto a seduta</i> <b>LSxPS</b>	<b>Codice</b>	
<input type="checkbox"/> 30 x 30 - (6 x 6)	26,5+31 x 26,5+31	<b>1R66LPC</b>	<input type="checkbox"/> 42 x 42 - (9 x 9)	39,5+44 x 39,5+44	<b>1R99LPC</b>	
<input type="checkbox"/> 30 x 33 - (6 x 7)	26,5+31 x 31+35	<b>1R67LPC</b>	<input type="checkbox"/> 42 x 46 - (9 x 10)	39,5+44 x 44+48,5	<b>1R910LPC</b>	
<input type="checkbox"/> 33 x 33 - (7 x 7)	31+35 x 31+35	<b>1R77LPC</b>	<input type="checkbox"/> 42 x 51 - (9 x 11)	39,5+44 x 48,5+52,5	<b>1R911LPC</b>	
<input type="checkbox"/> 33 x 38 - (7 x 8)	31+35 x 35+39,5	<b>1R78LPC</b>	<input type="checkbox"/> 46 x 38 - (10 x 8)	44+48,5 x 35+39,5	<b>1R108LPC</b>	
<input type="checkbox"/> 33 x 42 - (7 x 9)	31+35 x 39,5+44	<b>1R79LPC</b>	<input type="checkbox"/> 46 x 42 - (10 x 9)	44+48,5 x 39,5+44	<b>1R109LPC</b>	
<input type="checkbox"/> 38 x 33 - (8 x 7)	35+39,5 x 31+35	<b>1R87LPC</b>	<input type="checkbox"/> 46 x 46 - (10 x 10)	44+48,5 x 44+48,5	<b>1R1010LPC</b>	
<input type="checkbox"/> 38 x 38 - (8 x 8)	35+39,5 x 35+39,5	<b>1R88LPC</b>	<input type="checkbox"/> 46 x 51 - (10 x 11)	44+48,5 x 48,5+52,5	<b>1R1011LPC</b>	
<input type="checkbox"/> 38 x 42 - (8 x 9)	35+39,5 x 39,5+44	<b>1R89LPC</b>	<input type="checkbox"/> 51 x 42 - (11 x 9)	48,5+52,5 x 39,5+44	<b>1R119LPC</b>	
<input type="checkbox"/> 38 x 46 - (8 x 10)	35+39,5 x 44+48,5	<b>1R810LPC</b>	<input type="checkbox"/> 51 x 46 - (11 x 10)	48,5+52,5 x 44+48,5	<b>1R1110LPC</b>	
<input type="checkbox"/> 42 x 38 - (9 x 8)	39,5+44 x 35+39,5	<b>1R98LPC</b>	<input type="checkbox"/> 51 x 51 - (11 x 11)	48,5+52,5 x 48,5+52,5	<b>1R1111LPC</b>	

<b>O ROHO® QUADTRO SELECT® High Profile® altezza 10 cm</b>						<b>630,00</b>
<i>Misure cuscino</i> <b>LxP</b>	<i>Adatto a seduta</i> <b>LSxPS</b>	<b>Codice</b>	<i>Misure cuscino</i> <b>LxP</b>	<i>Adatto a seduta</i> <b>LSxPS</b>	<b>Codice</b>	
<input type="checkbox"/> 30 x 30 - (6 x 6)	26,5+31 x 26,5+31	<b>QS66C</b>	<input type="checkbox"/> 42 x 46 - (9 x 10)	39,5+44 x 44+48,5	<b>QS910C</b>	
<input type="checkbox"/> 30 x 33 - (6 x 7)	26,5+31 x 31+35	<b>QS67C</b>	<input type="checkbox"/> 42 x 51 - (9 x 11)	39,5+44 x 48,5+52,5	<b>QS911C</b>	
<input type="checkbox"/> 33 x 33 - (7 x 7)	31+35 x 31+35	<b>QS77C</b>	<input type="checkbox"/> 42 x 56 - (9 x 12)	39,5+44 x 52,5+57	<b>QS912C</b>	
<input type="checkbox"/> 33 x 38 - (7 x 8)	31+35 x 35+39,5	<b>QS78C</b>	<input type="checkbox"/> 46 x 38 - (10 x 8)	44+48,5 x 35+39,5	<b>QS108C</b>	
<input type="checkbox"/> 33 x 42 - (7 x 9)	31+35 x 39,5+44	<b>QS79C</b>	<input type="checkbox"/> 46 x 42 - (10 x 9)	44+48,5 x 39,5+44	<b>QS109C</b>	
<input type="checkbox"/> 38 x 33 - (8 x 7)	35+39,5 x 31+35	<b>QS87C</b>	<input type="checkbox"/> 46 x 46 - (10 x 10)	44+48,5 x 44+48,5	<b>QS1010C</b>	
<input type="checkbox"/> 38 x 38 - (8 x 8)	35+39,5 x 35+39,5	<b>QS88C</b>	<input type="checkbox"/> 46 x 51 - (10 x 11)	44+48,5 x 48,5+52,5	<b>QS1011C</b>	
<input type="checkbox"/> 38 x 42 - (8 x 9)	35+39,5 x 39,5+44	<b>QS89C</b>	<input type="checkbox"/> 46 x 56 - (10 x 12)	44+48,5 x 52,5+57	<b>QS1012C</b>	
<input type="checkbox"/> 38 x 46 - (8 x 10)	35+39,5 x 44+48,5	<b>QS810C</b>	<input type="checkbox"/> 51 x 42 - (11 x 9)	48,5+52,5 x 39,5+44	<b>QS119C</b>	
<input type="checkbox"/> 42 x 38 - (9 x 8)	39,5+44 x 35+39,5	<b>QS98C</b>	<input type="checkbox"/> 51 x 46 - (11 x 10)	48,5+52,5 x 44+48,5	<b>QS1110C</b>	
<input type="checkbox"/> 42 x 42 - (9 x 9)	39,5+44 x 39,5+44	<b>QS99C</b>	<input type="checkbox"/> 51 x 51 - (11 x 11)	48,5+52,5 x 48,5+52,5	<b>QS1111C</b>	

<b>O ROHO® QUADTRO SELECT® Low Profile® altezza 5 cm</b>						<b>630,00</b>
<i>Misure cuscino</i> <b>LxP</b>	<i>Adatto a seduta</i> <b>LSxPS</b>	<b>Codice</b>	<i>Misure cuscino</i> <b>LxP</b>	<i>Adatto a seduta</i> <b>LSxPS</b>	<b>Codice</b>	
<input type="checkbox"/> 28 x 30 - (5 x 6)	22+26,5 x 26,5+31	<b>QS56LPC</b>	<input type="checkbox"/> 42 x 42 - (9 x 9)	39,5+44 x 39,5+44	<b>QS99LPC</b>	
<input type="checkbox"/> 30 x 30 - (6 x 6)	26,5+31 x 26,5+31	<b>QS66LPC</b>	<input type="checkbox"/> 42 x 46 - (9 x 10)	39,5+44 x 44+48,5	<b>QS910LPC</b>	
<input type="checkbox"/> 30 x 33 - (6 x 7)	26,5+31 x 31+35	<b>QS67LPC</b>	<input type="checkbox"/> 42 x 51 - (9 x 11)	39,5+44 x 48,5+52,5	<b>QS911LPC</b>	
<input type="checkbox"/> 33 x 33 - (7 x 7)	31+35 x 31+35	<b>QS77LPC</b>	<input type="checkbox"/> 46 x 38 - (10 x 8)	44+48,5 x 35+39,5	<b>QS108LPC</b>	
<input type="checkbox"/> 33 x 38 - (7 x 8)	31+35 x 35+39,5	<b>QS78LPC</b>	<input type="checkbox"/> 46 x 42 - (10 x 9)	44+48,5 x 39,5+44	<b>QS109LPC</b>	
<input type="checkbox"/> 33 x 42 - (7 x 9)	31+35 x 39,5+44	<b>QS79LPC</b>	<input type="checkbox"/> 46 x 46 - (10 x 10)	44+48,5 x 44+48,5	<b>QS1010LPC</b>	
<input type="checkbox"/> 38 x 33 - (8 x 7)	35+39,5 x 31+35	<b>QS87LPC</b>	<input type="checkbox"/> 46 x 51 - (10 x 11)	44+48,5 x 48,5+52,5	<b>QS1011LPC</b>	
<input type="checkbox"/> 38 x 38 - (8 x 8)	35+39,5 x 35+39,5	<b>QS88LPC</b>	<input type="checkbox"/> 51 x 42 - (11 x 9)	48,5+52,5 x 39,5+44	<b>QS119LPC</b>	
<input type="checkbox"/> 38 x 42 - (8 x 9)	35+39,5 x 39,5+44	<b>QS89LPC</b>	<input type="checkbox"/> 51 x 46 - (11 x 10)	48,5+52,5 x 44+48,5	<b>QS1110LPC</b>	
<input type="checkbox"/> 38 x 46 - (8 x 10)	35+39,5 x 44+48,5	<b>QS810LPC</b>	<input type="checkbox"/> 51 x 51 - (11 x 11)	48,5+52,5 x 48,5+52,5	<b>QS1111LPC</b>	
<input type="checkbox"/> 42 x 38 - (9 x 8)	39,5+44 x 35+39,5	<b>QS98LPC</b>				

<b>O ROHO® CONTOUR SELECT®</b>						<b>630,00</b>
<i>Misure cuscino</i> <b>LxP</b>	<i>Adatto a seduta</i> <b>LSxPS</b>	<b>Codice</b>	<i>Misure cuscino</i> <b>LxP</b>	<i>Adatto a seduta</i> <b>LSxPS</b>	<b>Codice</b>	
<input type="checkbox"/> 33 x 38 - (7 x 8)	31+35 x 35+39,5	<b>CS78C</b>	<input type="checkbox"/> 42 x 51 - (9 x 11)	39,5+44 x 48,5+52,5	<b>CS911C</b>	
<input type="checkbox"/> 38 x 38 - (8 x 8)	35+39,5 x 35+39,5	<b>CS88C</b>	<input type="checkbox"/> 46 x 42 - (10 x 9)	44+48,5 x 39,5+44	<b>CS109C</b>	
<input type="checkbox"/> 38 x 42 - (8 x 9)	35+39,5 x 39,5+44	<b>CS89C</b>	<input type="checkbox"/> 46 x 46 - (10 x 10)	44+48,5 x 44+48,5	<b>CS1010C</b>	
<input type="checkbox"/> 38 x 46 - (8 x 10)	35+39,5 x 44+48,5	<b>CS810C</b>	<input type="checkbox"/> 46 x 51 - (10 x 11)	44+48,5 x 48,5+52,5	<b>CS1011C</b>	
<input type="checkbox"/> 42 x 38 - (9 x 8)	39,5+44 x 35+39,5	<b>CS98C</b>	<input type="checkbox"/> 51 x 42 - (11 x 9)	48,5+52,5 x 39,5+44	<b>CS119C</b>	
<input type="checkbox"/> 42 x 42 - (9 x 9)	39,5+44 x 39,5+44	<b>CS99C</b>	<input type="checkbox"/> 51 x 46 - (11 x 10)	48,5+52,5 x 44+48,5	<b>CS1110C</b>	
<input type="checkbox"/> 42 x 46 - (9 x 10)	39,5+44 x 44+48,5	<b>CS910C</b>	<input type="checkbox"/> 51 x 51 - (11 x 11)	48,5+52,5 x 48,5+52,5	<b>CS1111C</b>	

<b>O ROHO® ENHANCER®</b>						<b>630,00</b>
<i>Misure cuscino</i> <b>LxP</b>	<i>Adatto a seduta</i> <b>LSxPS</b>	<b>Codice</b>	<i>Misure cuscino</i> <b>LxP</b>	<i>Adatto a seduta</i> <b>LSxPS</b>	<b>Codice</b>	
<input type="checkbox"/> 38 x 38 - (8 x 8)	35+39,5 x 35+39,5	<b>ENH88C</b>	<input type="checkbox"/> 46 x 42 - (10 x 9)	44+48,5 x 39,5+44	<b>ENH109C</b>	
<input type="checkbox"/> 38 x 42 - (8 x 9)	35+39,5 x 39,5+44	<b>ENH89C</b>	<input type="checkbox"/> 46 x 46 - (10 x 10)	44+48,5 x 44+48,5	<b>ENH1010C</b>	
<input type="checkbox"/> 42 x 38 - (9 x 8)	39,5+44 x 35+39,5	<b>ENH98C</b>	<input type="checkbox"/> 46 x 51 - (10 x 11)	44+48,5 x 48,5+52,5	<b>ENH1011C</b>	
<input type="checkbox"/> 42 x 42 - (9 x 9)	39,5+44 x 39,5+44	<b>ENH99C</b>	<input type="checkbox"/> 51 x 46 - (11 x 10)	48,5+52,5 x 44+48,5	<b>ENH1110C</b>	
<input type="checkbox"/> 42 x 46 - (9 x 10)	39,5+44 x 44+48,5	<b>ENH910C</b>				

Carrozina : Progeo YOGA - Rev. 2023.0	Prezzo IVA esclusa da sommare al prezzo di listino	Pagina da inviare se sono stati scelti optional <input checked="" type="checkbox"/> <b>standard</b> (fornito in assenza di altre indicazioni) <input type="checkbox"/> <b>su richiesta</b> (senza aggiunta di prezzo) <input type="checkbox"/> <b>optional</b> (sommare il prezzo a quello di listino)
---------------------------------------	---	---

Rehaleam s.r.l. - Vicolo Negrelli, 5 - 31038 Castagnole di Paese (TV) - Tel. +39 0422 484657/+39 0422 480367 - Fax +39 0422 484661/+39 0422 484684 - P.IVA IT 03182520266 - C.C.I.A.A. TV n.225867 - iscr.Trib. TV n.41690 Capitale Sociale I.V. Euro 100.000,00  
 la società è soggetta ex art. 2497-bis C.C. al coordinamento e direzione della società "PERMOBIL ITALY SRL" iscritta al Registro Imprese Milano Monza Brianza Lodi 10246110968

Email: info\_it@permobil.com - web: http://www.rehaleamprogeo.com



Rehateam s.r.l. - Vicoletto Negrelli, 5 - 31038 Castagnole di Paese (TV) - Tel. +39.0422.484657/+39.0422.480387 - Fax +39.0422.484651/+39.0422.484684 - P.IVA IT 03182520266 - C.C.I.A.A. TV n.41690 Capitale Sociale I.V. Euro 100.000,00 la società è soggetta ex art. 2497-bis C.C. al coordinamento e direzione della società "PERMOBIL ITALY SRL" iscritta al Registro Imprese - Milano Monza Brianza Lodi 10246110968

Data	Commessa	Utilizzatore	Indirizzo
------	----------	--------------	-----------

- Ruota 12" - Motore 250W (potenza massima 750W)
  - Ruota 14" - Motore 1000W (potenza massima 1500W)
  - Display a colori con pulsantiera
  - Limite di velocità massima impostabile da display
  - 5 livelli di velocità selezionabili
  - 10 livelli di accelerazione selezionabili da display
  - Cruise control adattivo (mantiene velocità anche in discesa)
  - Leva di comando freno a disco ed elettronico
  - Freno motore (regolabile in 10 livelli da display)
  - Freno elettronico a pulsante (regolabile in 10 livelli da display)
  - Recupero energia in frenata
  - Gestione messaggi di errore da display (con registro storico)
  - Segnalatore acustico retromarcia
  - Batteria 48V - 5,8Ah Autonomia fino a 25km
  - Batteria potenziata 48V - 11,6Ah Autonomia fino a 50km
  - Caricabatteria 48V
  - Retromarcia
  - Ingresso USB
  - Cavalletto di stazionamento
  - Parafango ruota
  - Cupolino anteriore con predisposizione faro FULL LED
- (Software certificato)**



10979 **3.800,00**

**○ Mototronic**

- Codici di riconducibilità Nomenclatore Tariffario
- Riconducibile N.T. Cod. 12.21.27.006 - Carrozzina elettrica ad uso interno/esterno oppure
- Riconducibile N.T. Cod. 12.24.09.015 - Kit di motorizzazione universale per carrozzine

**Manubrio**

☆ Comandi STANDARD

☆ Acceleratore a pollice e Leva di comando freno a disco ed elettronico (Destra)

○ Acceleratore a manopola e Leva di comando freno a disco ed elettronico

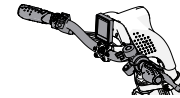

- Destra
- Sinistra

10913 **40,00**  
10914 **40,00**

**○ Comandi per TETRAPLEGICI**  
Manubrio PUSH&PULL

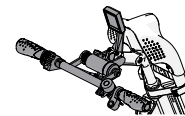

10905 **490,00**

☆ **MOTOTRONIK Ruota 12"**

Motore 250W (potenza massima 750W)  
Velocità massima secondo norma di legge

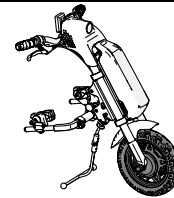

**○ MOTOTRONIK Ruota 14"**

Motore 1000W (potenza massima 1500W)  
Velocità massima secondo norma di legge

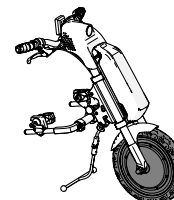

10903 **440,00**

**Batteria**





☆ Batteria 48V - 5,8Ah Autonomia fino a 25 km

○ Batteria potenziata 48V - 11,6Ah Autonomia fino a 50 km

10904 **330,00**

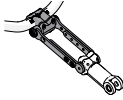
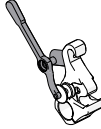
Rehateam s.r.l. Vicolo Negrelli, 5 - 31038 Castagnole di Paese (TV) - Tel. +39.0422.484657/+39.0422.480387 - Fax +39.0422.484651/+39.0422.484684 - P.IVA IT 03182520266 - C.C.I.A.A. TV n.225867 - Iscr. Trib. TV n.41690 Capitale Sociale I.V. Euro 100.000,00  
 la società è soggetta ex art. 2497-bis C.C. al coordinamento e direzione della società "PERMOBIL ITALY SRL" iscritta al Registro Imprese Milano Monza Brianza Lodi 10246110968

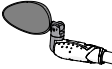
Data .....	Commessa .....	Utilizzatore .....	Indirizzo .....
------------	----------------	--------------------	-----------------

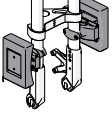
<b>Accessori</b>			
<input type="radio"/> Prolunga manubrio (avvicinamento guida) Regolabile da 15cm fino a 23cm		10907	<b>190,00</b>
<input type="radio"/> Leva sgancio facilitato gruppo motore Consigliato con manubrio per tetraplegici		10915	<b>80,00</b>
<input type="radio"/> FLY Batteria aggiuntiva 48V - 2,9Ah Autonomia fino a 15km Omologata per trasporto aereo		10906	<b>600,00</b>
<input type="radio"/> Faro FULL LED (alta intensità) Incorporato sul cupolino		10908	<b>110,00</b>
<input type="radio"/> Specchietto retrovisore	<input type="radio"/> Destro <input type="radio"/> Sinistro	 10909 10909	<b>40,00</b> <b>40,00</b>
<input type="radio"/> Cestino (removibile) - (con sistema di aggancio KCLICKfix®)		10912	<b>200,00</b>
<input type="radio"/> Zavorra anteriore removibile - (con sistema di aggancio KCLICKfix®) (Aumenta il peso della ruota motrice per migliorare la trazione)		10910	<b>300,00</b>
<input type="radio"/> Sacca da trasporto		10916	<b>150,00</b>

## Note

<b>Carrozzina : Progeo YOGA - Rev. 2023.0</b>	<b>Prezzo IVA esclusa</b> da sommare al prezzo di listino	<table border="1" style="width:100%; border-collapse: collapse;"> <thead> <tr> <th colspan="2" style="text-align: left; padding: 2px;">Pagina da inviare se sono stati scelti optional</th> </tr> </thead> <tbody> <tr> <td style="width:10%; text-align: center; padding: 2px;">☆</td> <td style="padding: 2px;">standard (fornito in assenza di altre indicazioni)</td> </tr> <tr> <td style="text-align: center; padding: 2px;">□</td> <td style="padding: 2px;">su richiesta (senza aggiunta di prezzo)</td> </tr> <tr> <td style="text-align: center; padding: 2px;">○</td> <td style="padding: 2px;">optional (sommare il prezzo a quello di listino)</td> </tr> </tbody> </table>	Pagina da inviare se sono stati scelti optional		☆	standard (fornito in assenza di altre indicazioni)	□	su richiesta (senza aggiunta di prezzo)	○	optional (sommare il prezzo a quello di listino)
Pagina da inviare se sono stati scelti optional										
☆	standard (fornito in assenza di altre indicazioni)									
□	su richiesta (senza aggiunta di prezzo)									
○	optional (sommare il prezzo a quello di listino)									

Email: info\_it@permobil.com - web: http://www.rehateamprogeo.com

Data ..... Comnessa ..... Utilizzatore ..... Indirizzo .....

**SMARTDRIVE**



**SMARTDRIVE MX2 - 6KM/H**  
compreso di caricabatteria

- SWITCH CONTROL (DX+SX) - EU MX2-S002 4.000,00
- SWITCH CONTROL + JACK 3.5 - EU MX2-S003 4.000,00
- SPEED CONTROL DIAL - EU MX2-S001 4.250,00

**SMARTDRIVE MX2 - 9KM/H**  
compreso di caricabatteria

- SWITCH CONTROL (DX+SX) - EU MX2-S005 4.100,00
- SWITCH CONTROL + JACK 3.5 - EU MX2-S006 4.100,00
- SPEED CONTROL DIAL - EU MX2-S004 4.350,00

**SWITCH CONTROL**



**SWITCH CONTROL + JACK (3,5 mono)**



Ingresso femmina Mono, permette di collegare SmartDrive con un qualsiasi altro dispositivo di comando/guida.

**SPEED CONTROL DIAL**



Manopola di controllo graduale della velocità

**KIT FISSAGGIO TELAIO PIEGHEVOLE**

Scegliere kit di fissaggio in funzione della misura delle ruote posteriori della carrozzina

- kit fissaggio telaio pieghevole - ruote posteriori 22" - 24" MX2-443-C
- kit fissaggio telaio pieghevole - ruote posteriori 25" MX2-453-C
- kit fissaggio telaio pieghevole - ruote posteriori 26" MX2-463-C

**PUSHTRACKER**

- ☆ SENZA Push Tracker MX2-NOPT
- Userò il mio Apple Watch (non fornito da Permobil)  
Configurazione semplice e veloce  
Maggiore visibilità dello schermo  
Prestazioni della batteria migliorate  
App gratuita su Apple Store  
Compatibile con Apple Watch 5 e successivi, iOS8 e successivi.
- PushTracker E3 Basic MX2-33P 250,00  
Nessun telefono/Wi-Fi richiesto  
App precaricate per una facile configurazione in pochi minuti  
Più piccolo, più leggero e più comodo  
Migliore durata della batteria  
Più reattivo ed efficiente
- PushTracker E3 MX2-33S 250,00  
Richiede l'installazione e configurazione completa da parte dell'utente  
Connesso con il tuo telefono cellulare ha tutte le funzionalità di uno Smartwatch.



**Accessori**

- Borsa da trasporto MX2SD-BAG 60,00
- Maniglia universale imbottita  
*Maniglia universale imbottita* MX2-986 20,00



**Pagina da inviare se sono stati scelti optional**

- ☆ standard (fornito in assenza di altre indicazioni)
- su richiesta (senza aggiunta di prezzo)
- optional (sommare il prezzo a quello di listino)

Carrozzina : Progeo YOGA - Rev. 2023.0

Prezzo IVA esclusa  
da sommare al prezzo di listino

Rehateam s.r.l. Vicolo Negrelli, 5 - 31038 Castagnole di Paese (TV) - Tel. +39.0422.484657/+39.0422.480387 - Fax +39.0422.484661/+39.0422.484684 - P.IVA IT 03182520266 - C.C.I.A.A. TV n.41690 Capitale Sociale i.V. Euro 100.000,00 la società è soggetta ex art. 2497-bis C.C. al coordinamento e direzione della società "PERMOBIL ITALY SRL" iscritta al Registro Imprese Milano Monza Brianza Lodi 10246110968

Email: info\_it@permobil.com - web: http://www.rehateamprogeo.com